



Complete Specification Sheet

Zolo 5 Static White

ZOLO



Zolo™ 5 Static White

Ultra-Thin LED Washer/Grazer



Specifications

Category	Fixture
Series	Zolo 5
Family	Static White
Watts per Foot	8 W/ft
IP Rating	IP66
CRI	85
CCT Options	2700K, 3000K, 3500K, 4000K, 5000K
Input Voltage	24V DC
Max Run Length	11ft (3.4m)
Beam Angle	25°, 30°, 50°, 25°×40°, 30°×55°
Lumens per Foot	700 lm/ft
Storage Temp.	-22°F (-30°C) to 140°F (60°C)
Operating Temp.	-40°F (-40°C) to 140°F (60°C)
Dimming Options	Dimming Available (Consult Factory for options)

Features

- High Purity Tempered Glass
- Multiple Optics Options Available
- Extruded Aluminum Alloy Housing
- Available in Titanium Gray, Black, or White Finish
- Multi-Volt 24VDC Remote Driver (Sold Separately)
- Daisy Chain Multiple Fixtures
- Optional Glare Control Accessories
- Louver Options Available

Description

Zolo 5 is a washer/grazer with a small form factor, great light output, and is highly customizable to perfectly fit your project.

Dimensions

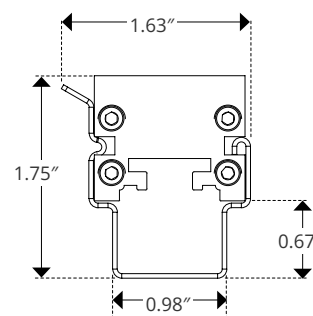
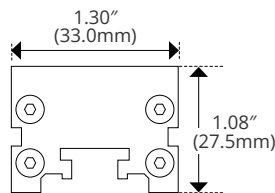
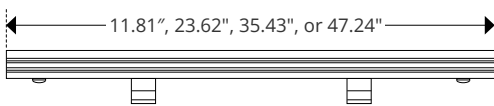

Kelvix reserves the right to update the product specifications at any time. To maintain warranty, field modifications must follow approved Kelvix installation instruction.
Conforms to ANSI/UL Standard 2108
Certified to CAN/CSA Standard C22.2 No. 250.2

Fixture Type _____

Project Name _____

Location _____



Product Code Builder

Zolo 5 Static White

Product Code Builder

Example: Z5-1-8W-27-25-S1-TG-NA

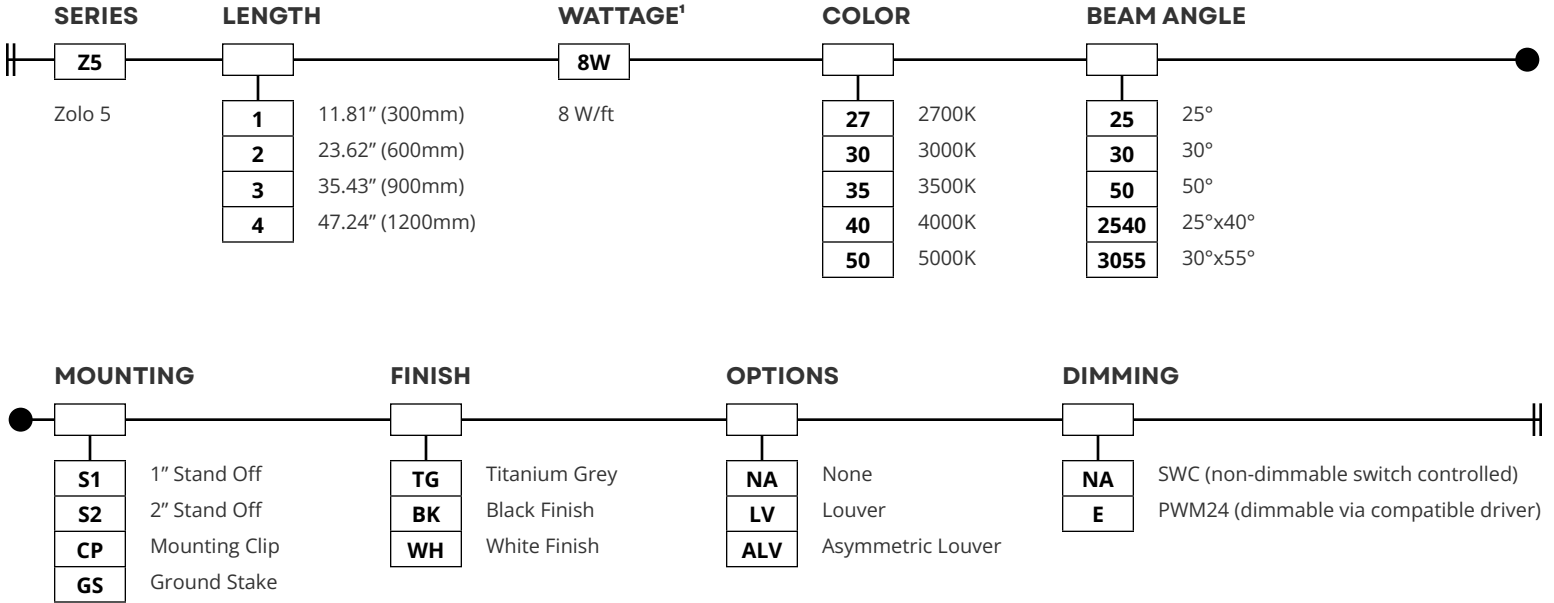

¹Other options available, consult factory.

MOUNTING

1" Stand Off



S1

2" Stand Off



S2

Mounting Clip



CP

Ground Stake



GS

FINISH

Titanium Grey



RAL 9006

TG

Black

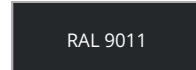

RAL 9011

BK

White

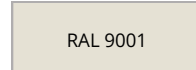

RAL 9001

WH

OPTIONS

Louver



LV

Asymmetric Louver



ALV

Kelvix reserves the right to update the product specifications at any time. To maintain warranty, field modifications must follow approved Kelvix installation instruction.
 Conforms to ANSI/UL Standard 2108
 Certified to CAN/CSA Standard C22.2 No. 250.2

Fixture Type _____

Project Name _____

Location _____



Mounting Details

Zolo 5 Static White

Mounting

TYPE

1" Stand Off



DESCRIPTION

S1	
Width	1.25in (32.0mm)
Length	0.70in (18.0mm)
Height w/ Product	2.21in (56.13mm)
Stand Off Height	1.13in (28.7mm)
Rotation	75°

DIMENSIONS

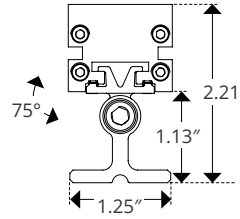

2" Stand Off



S2	
Width	1.65in (42.0mm)
Length	0.71in (18.0mm)
Height w/ Product	3.33in (84.6mm)
Stand Off Height	2.24in (57.0mm)
Rotation	105°

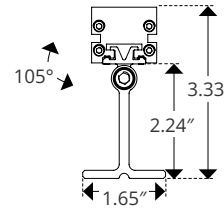

Mounting Clip



CP	
Width	1.63in (41.0mm)
Length	1.18in (30.0mm)
Height	1.75in (44.45mm)
Stand Off Height	0.67in (17.0mm)

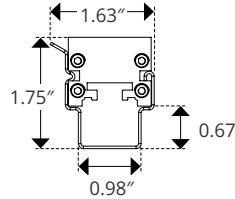

Ground Stake



GS	
Diameter (Width)	ø2.05in (52.1mm)
Diameter (Length)	ø2.05in (52.1mm)
Height	9.51in (241.6mm)
Height w/ Product	10.60in (229.24mm)
Rotation	95°

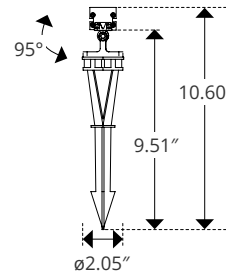



Optional Accessories

Zolo 5 Static White

Options

TYPE

Louwer



DESCRIPTION



Width	1.46in (37.0mm)
Stand Off Height	0.39in (10.0mm)
Height w Product	1.48in (37.5mm)
Height	1.18in (30.0mm)

DIMENSIONS

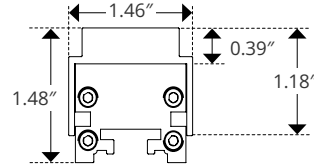

Asymmetric Louwer



Width	1.46in (37.0mm)
Stand Off Height	0.39in (10.0mm)
Height w Product	1.48in (37.5mm)
Height	1.18in (30.0mm)

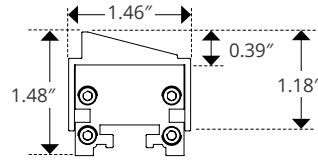



Power and Connector Details

Zolo 5 Static White

Connectors

TYPE

Connector



DESCRIPTION

Order Code	Length
Z-57-FML-6	6ft (1.8M)
Z-57-FML-20	20ft (6M)
Z-57-FML-50	50ft (15.2M)

WIRING GUIDE

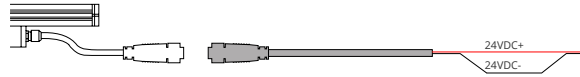

Connector



Order Code	Length
Z-57-FMC-1	1ft (0.30M)
Z-57-FMC-2	2ft (0.61M)
Z-57-FMC-6	6ft (1.8M)



End Cap



Order Code
Z-57-EC

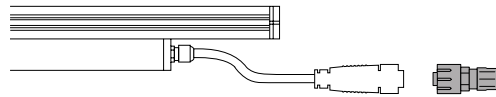

Kelvix reserves the right to update the product specifications at any time. To maintain warranty, field modifications must follow approved Kelvix installation instruction.
 Conforms to ANSI/UL Standard 2108
 Certified to CAN/CSA Standard C22.2 No. 250.2

Fixture Type _____

Project Name _____

Location _____