

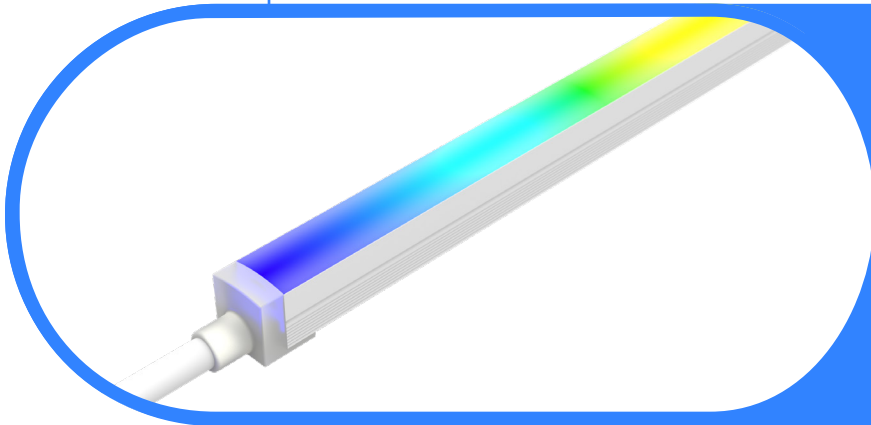

Complete Specification Sheet

Endurawave Narrow DMX Pixel

FLEXIBLE
NEON



Endurawave Narrow DMX Pixel

0.79" x 0.79" Narrow View

Flexible Neon



Specifications

Category	Flexible Neon
Series	Endurawave Narrow
Family	DMX Pixel
Watts per Foot	5.88 W
IP Rating	IP67/IP68
Color Options	RGBW-27K, RGBW-30K, RGBW-40K, RGBW-60K
Input Voltage	24V DC
Width	0.79in (20mm)
Height	0.79in (20mm)
Max Run Length	16.41ft (5m)
Cut Interval / Pixel Size	1.97in (50mm)
Feed Orientation	Bottom Feed, End Feed, Side Right, Side Left
Material	Silicone
Bend Diameter	V: 11.81" (300mm) / H: 31.50" (800mm)
Bend Direction	3D Bend (Horizontal and Vertical)
Beam Angle	115°
Lumens per Foot	113-125 lm/ft
Viewing Angle	Narrow
Life Expectancy	50,000 Hour Life
Storage Temp.	-4°F (-20°C) to 158°F (70°C)
Operating Temp.	-4°F (-20°C) to 140°F (60°C)
Dimming Chip Type	TM512AC via Integral Decoder
Dimming Options	DMX512

Features

- Strong Tensile Strength
- RGBW Pixel control with DMX512
- TM512AC Chip
- Integral Decoder
- 50,000 Hour Life
- Silicone Jacket with IP67 or IP68 Options
- UL-Listed for Indoor and Outdoor Use
- For Use with 24V Power Supplies

Description

Endurawave revolutionizes flexibility with its rigid PCB encased in a protective shell, allowing seamless bending and twisting without compromising LEDs or components. Reinforced by durable steel wires, it ensures long daisy-chain connections with superior tensile strength and 3D bending functionality.

Application



Kelvix reserves the right to update the product specifications at any time. Field modifications will void UL listing and warranty. Conforms to ANSI/UL Standard 2108. Certified to CAN/CSA Standard C22.2 No. 250.2 5% tolerance for all listed data

Fixture Type _____

Project Name _____

Location _____



Product Code Builder

Endurawave Narrow DMX Pixel

FLEXIBLE
NEON

Product Code Builder

Example: ENN-TX-RGBW2-24V-E67-1-10

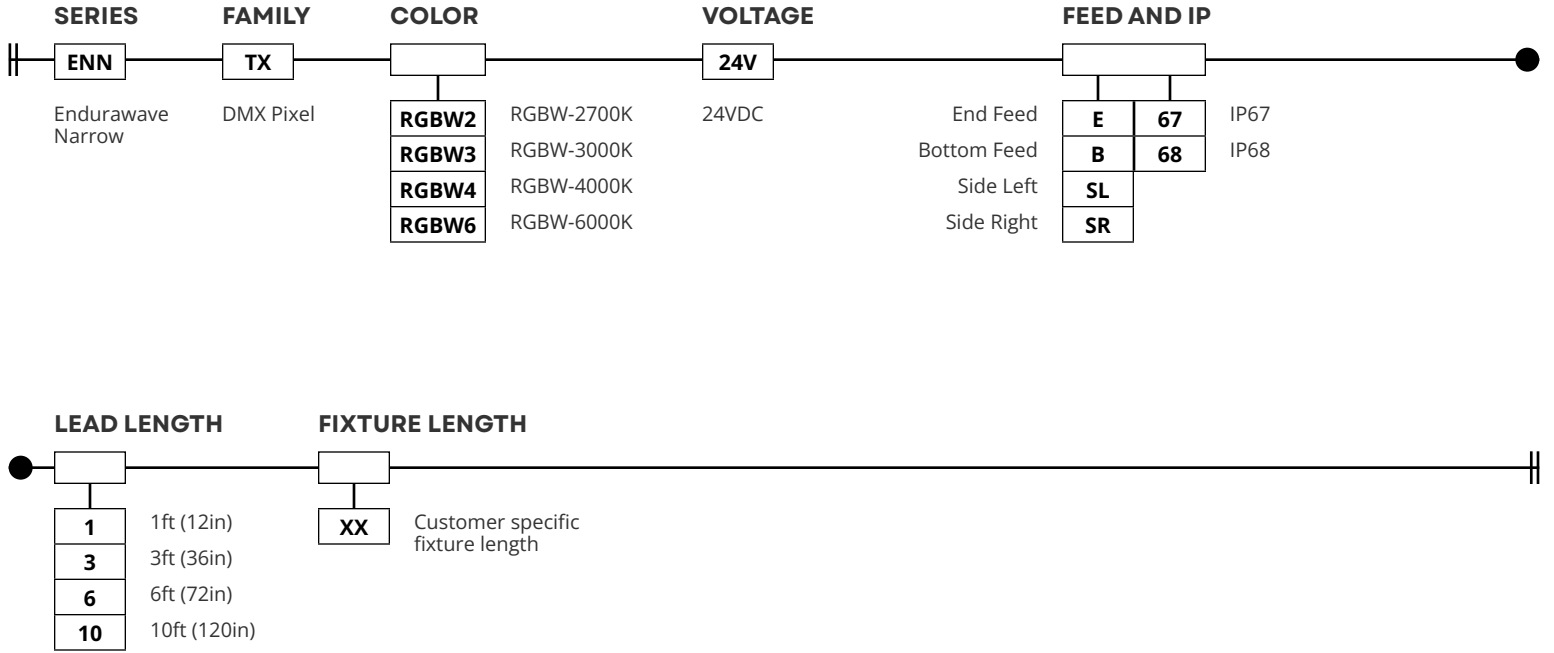

Color	Lumens per Foot
RGBW2	109 lm
RGBW3	120 lm
RGBW4	108 lm
RGBW6	120 lm

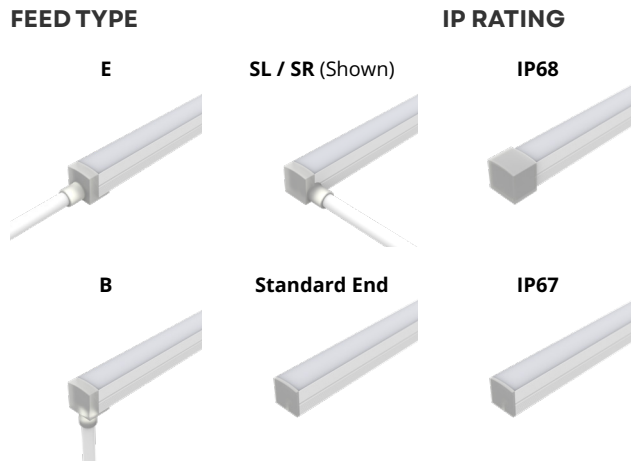

Description	Wire Gauge
5 Conductor Leader Cable (1ft)	1 x 16AWG 4 x 20AWG
5 Conductor Leader Cable (3ft)	1 x 16AWG 4 x 20AWG
5 Conductor Leader Cable (6ft)	1 x 16AWG 4 x 20AWG
5 Conductor Leader Cable (10ft)	1 x 16AWG 4 x 20AWG

Kelvix reserves the right to update the product specifications at any time. Field modifications will void UL listing and warranty. Conforms to ANSI/UL Standard 2108. Certified to CAN/CSA Standard C22.2 No. 250.2 5% tolerance for all listed data

Fixture Type _____

Project Name _____

Location _____



Product Details

Endurawave Narrow DMX Pixel

FLEXIBLE
NEON

Photometric

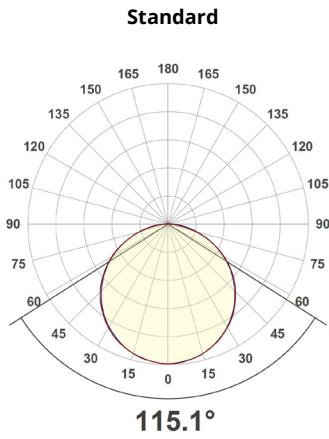

Performance

Color	CRI	Lumens per Foot	Input Voltage	W/ft
RGBW2	90+ (White)	169 lm	24VDC	5.95 W
RGBW3		169 lm		
RGBW4		181 lm		
RGBW6		175 lm		

Leader Cables

Description	Ordering Code	Length	Wire Gauge
5 Conductor Leader Cable (1ft)	1	1 ft	2 x 18AWG 3 x 22AWG
5 Conductor Leader Cable (3ft)	3	3 ft	2 x 18AWG 3 x 22AWG
5 Conductor Leader Cable (6ft)	6	6 ft	2 x 18AWG 3 x 22AWG
5 Conductor Leader Cable (10ft)	10	10 ft	2 x 18AWG 3 x 22AWG

Dimensions

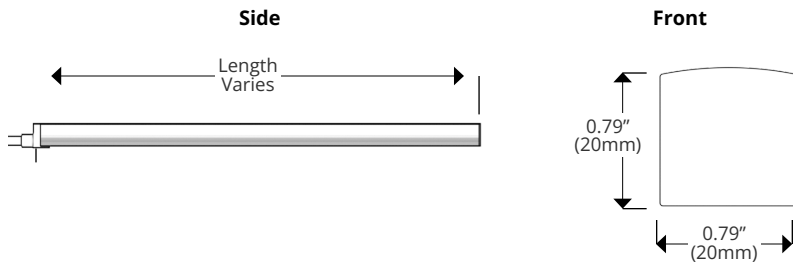

Bend Direction

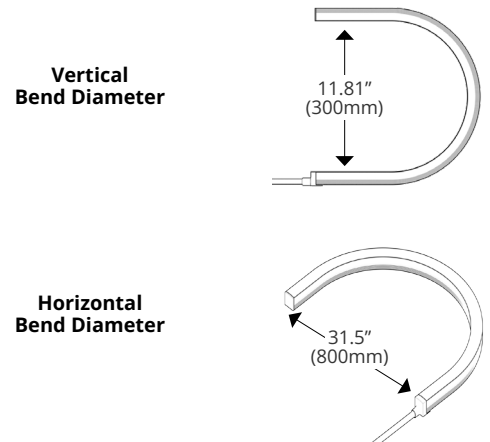

Kelvix reserves the right to update the product specifications at any time. Field modifications will void UL listing and warranty. Conforms to ANSI/UL Standard 2108. Certified to CAN/CSA Standard C22.2 No. 250.2 5% tolerance for all listed data

Fixture Type _____

Project Name _____

Location _____



End Feed Options

Endurawave Narrow Series

FLEXIBLE
NEON

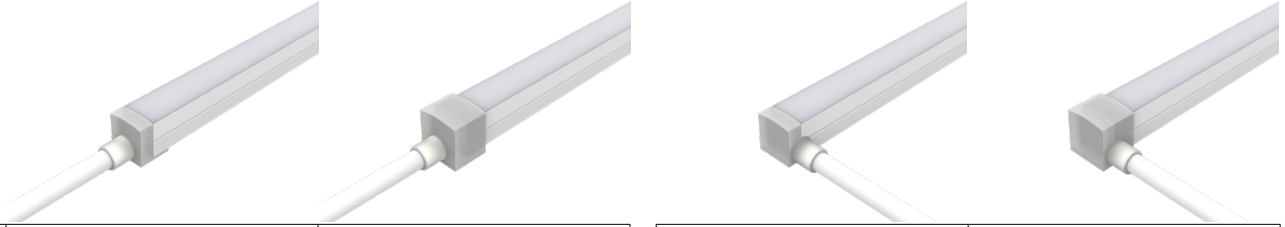

	IP67	IP68
Type	End Feed (E)	
Length Adder	0.31in (8mm)	0.31in (8mm)
Length	0.69in (17.5mm)	0.98in (25mm)
Width	0.85in (21.5mm)	0.91in (23.2mm)
Height	0.85in (21.5mm)	0.91in (23.2mm)

	IP67	IP68
Type	Side Feed Left (SL) / Side Feed Right (SR) (SR Shown)	
Length Adder	0.31in (8mm)	0.31in (8mm)
Length	0.71in (18mm)	0.98in (25mm)
Width	0.85in (21.5mm)	0.91in (23.2mm)
Height	0.85in (21.5mm)	0.91in (23.2mm)

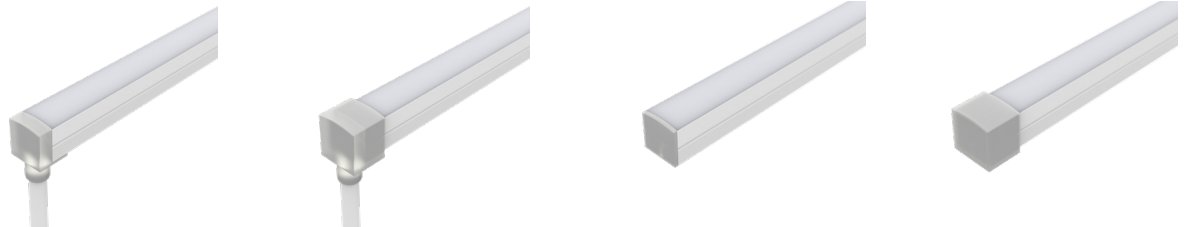
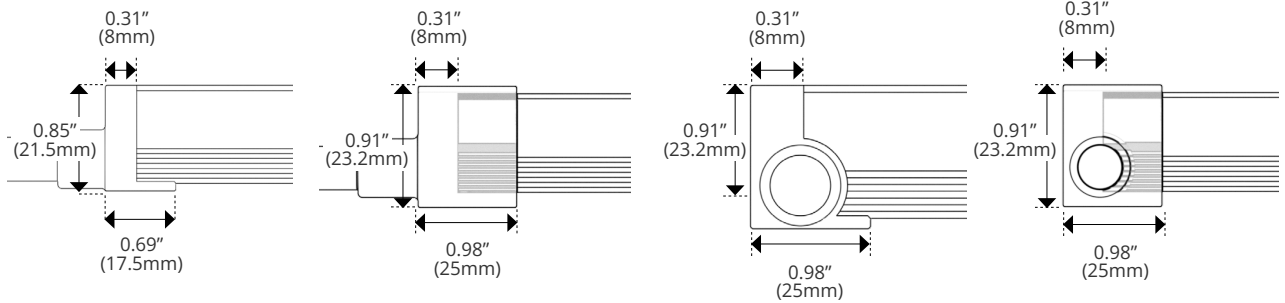

	IP67	IP68
Type	Back Feed (B)	
Length Adder	0.31in (8mm)	0.31in (8mm)
Length	0.71in (18mm)	0.98in (25mm)
Width	0.85in (21.5mm)	0.91in (23.2mm)
Height	0.85in (21.5mm)	0.91in (23.2mm)

	IP67	IP68
Type	End Cap	
Length Adder	0.08in (2mm)	0.08in (2mm)
Length	2mm	0.79in (20mm)
Width	0.79in (20mm)	0.91in (23.2mm)
Height	0.79in (20mm)	0.91in (23.2mm)

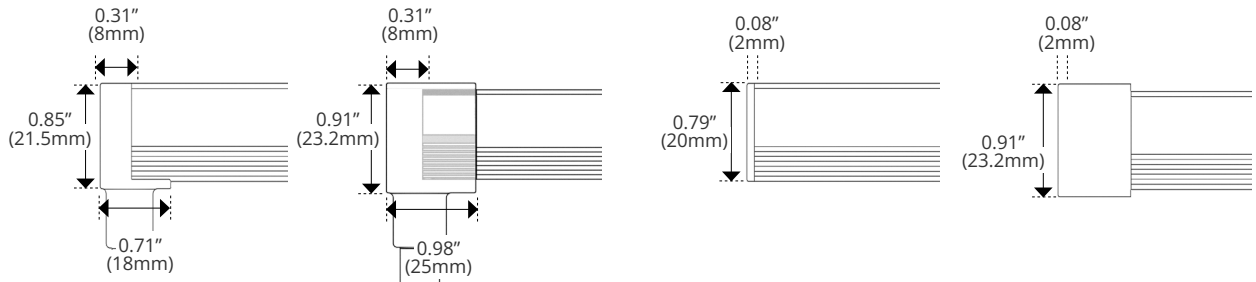

Kelvix reserves the right to update the product specifications at any time. Field modifications will void UL listing and warranty. Conforms to ANSI/UL Standard 2108. Certified to CAN/CSA Standard C22.2 No. 250.2 5% tolerance for all listed data

Fixture Type _____

Project Name _____

Location _____



Mounting Options

Endurawave Narrow Series

IMAGE

SPECIFICATIONS

MOUNTING DIMENSIONS

DIMENSIONS WITH PRODUCT

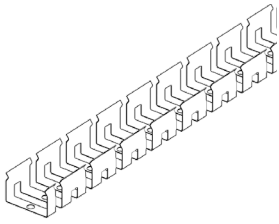

ENN-CH-SS-FLX-1M	
Length	39.37in (1,000mm)
Width	0.85in (21.7mm)
Height	0.54in (13.7mm)

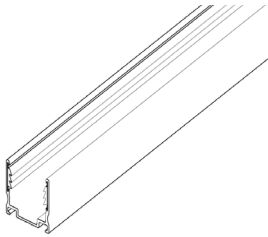
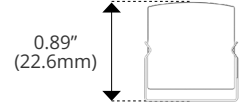
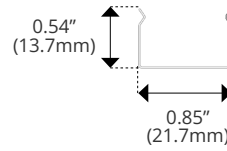

ENN-CH-AL-SR-2M	
Length	78.74in (2,000mm)
Width	0.98in (25mm)
Height	0.91in (23mm)

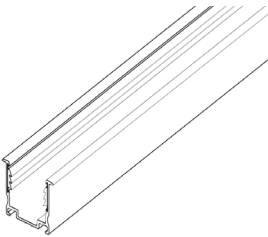
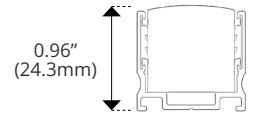
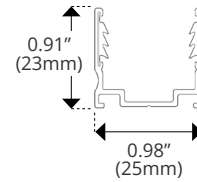

ENN-CH-AL-SR-RC-2M	
Length	78.74in (2,000mm)
Width	1.18in (30mm)
Height	0.91in (23mm)

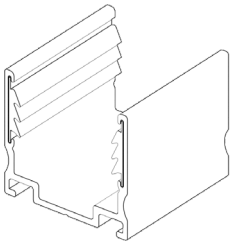
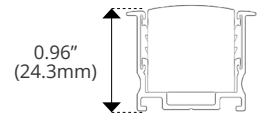
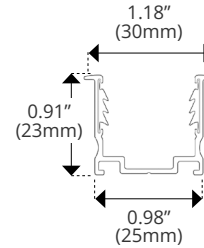

ENN-CLP-AL-SR	
Length	1.38in (35mm)
Width	0.98in (25mm)
Height	0.91in (23mm)

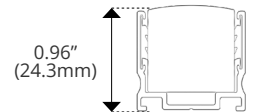
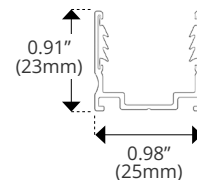



Addressing Details

Endurawave Narrow DMX Pixel

IMAGE



SPECIFICATIONS

ENN-ADR	
Length	3.93in (100.0mm)
Width	5.51in (140.0mm)
Height	1.57in (40.0mm)
Power	DC5-24V or integrated battery power. Rechargeable via USB-C
DMX Connectors	Terminal Block

DETAILS

Wired DMX Addressing device for use with Endurawave DMX Pixel Fixtures.

Note: All Endurawave DMX Pixel Fixtures will come factory preset to start at DMX address 1, with sequential addressing along the fixture.

Fixture Type _____

Project Name _____

Location _____