



VINE™

VN-SERIES | FLEXIBLE LIGHTING SYSTEM

Fixture Type: _____

Project: _____

Location: _____



MODEL:	VN24K	VN27K	VN30K	VN35K	VN40K
Kelvin	2400K	2700K	3000K	3500K	4000K
Lumens	230 lm/ft	268 lm/ft	275 lm/ft	281 lm/ft	290 lm/ft

PRODUCT FEATURES

- 360° Continuous Light Source
- Universal Dimming
- Five Mounting Options
- 36,000 Hour Life
- IP65 Rated for Outdoor Use
- Factory-Installed Power Feed
- Injection-Molded Flush End Caps
- For Use with 24V Power Supplies

SPECIFICATIONS

Series	VN—Vine™
Input Voltage	24V DC
Watts per Foot	4.39 W/FT
Max Run Length	Unlimited, Power Feed Every 16.4ft
Beam Angle	360°
Dimensions	1" (25mm)
Bend Radius	4.72" (120mm)
CRI	90+
Dimming Options	PWM, Triac, 0-10V, DMX, Hi-lume
Temp Range	-22°F (-30°C) to 131°F (55°C)

ORDERING INFORMATION

Example: **VN-25-48-30K-E-72**

Series	Diameter	Length (Unlimited)	Color	Feed Point	Feed Length
VN	25			E	
VN - Vine	25 - 1 Inch (25mm)	Inches	24K - 2400K 27K - 2700K 30K - 3000K 35K - 3500K 40K - 4000K	E - End Feed	72 - 72 Inch (Standard) 192 - 192 Inch

Conforms to ANSI/UL Standard 2108
 Certified to CAN/CSA Standard C22.2 No. 250.0





VINE™ MOUNTING AND ACCESSORIES

VISIBLE MOUNTING CLIP



SPECIFICATIONS

Model	VN-25-CP
Material	Clear Polycarbonate
Length	0.984" (25mm)
Width	2.032" (51.6mm)
Height	1.063" (27mm)
Internal Width	1" (25.4mm)

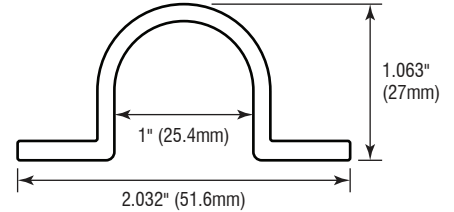

**Surface Mounts Straight
or Curved Runs**

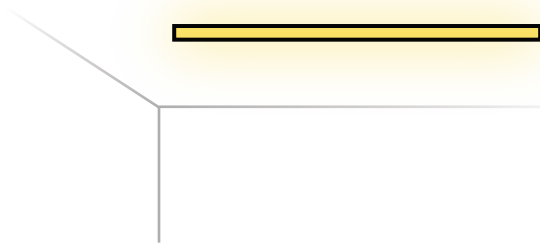

OR



CONCEALED MOUNTING CLIP



SPECIFICATIONS

Model	VN-25-CCP
Material	Clear Polycarbonate
Length	1.43" (36mm)
Width	0.75" (19mm)
Height	0.27" (7mm)
Effective Height	0.11" (3mm)

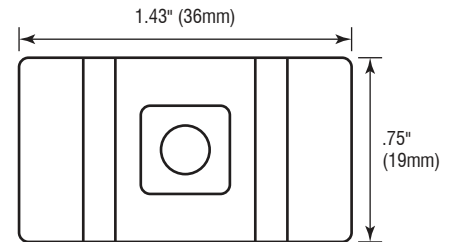

**Surface Mounts Straight
or Curved Runs**

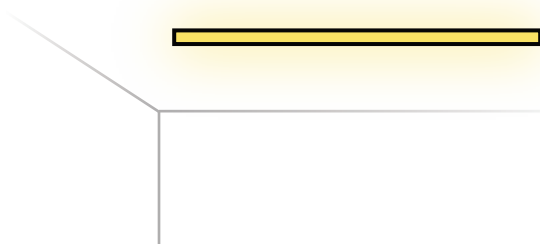

OR





VINE™ MOUNTING AND ACCESSORIES

SPLICE



SPECIFICATIONS

Model	VN-25-CS
Material	Aluminum
Length	1.358" (34.5mm)
Diameter	1.22" (31mm)
Internal Diameter	1" (25.4mm)

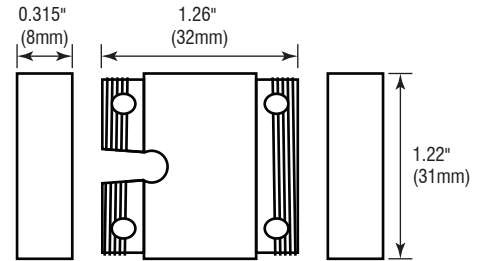

**Connects Power Feed
End to Terminal End**

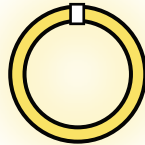

ARCH



SPECIFICATIONS

Model	VN-25-MA-FF
Material	Aluminum
Length	1.654" (42mm)
Diameter	1.28" (32.5mm)
Internal Diameter	1" (25.4mm)

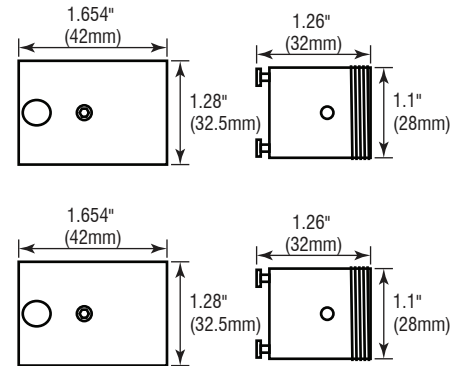

**Surface Mounts Power Feed
End and Terminal End**

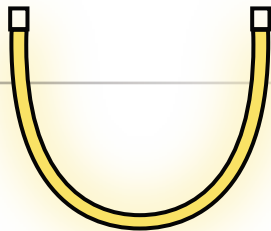



VINE™ MOUNTING AND ACCESSORIES

FLUSH PENDANT

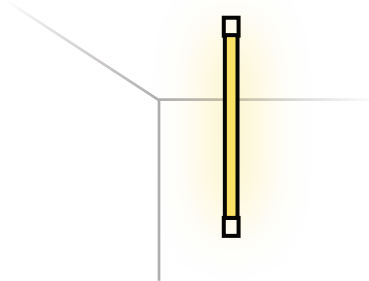

SPECIFICATIONS

Model	VN-25-FP-FF
Model w/ Sleeve*	VN-25-FP-XXX
Material	Aluminum
EC Length	1.32" (33.5mm)
EC Diameter	1.24" (31.5mm)
CM Length	1.654" (42mm)
CM Diameter	1.28" (32.5mm)
Internal Diameter	1" (25.4mm)

*Polycarbonate sleeve (not pictured) is required for Vine to hang perfectly vertical. XXX is the sleeve length in inches.

EC—End Cap

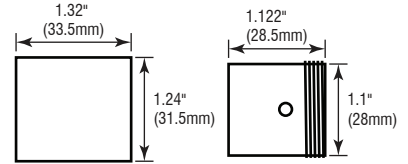

CM—Ceiling Mount

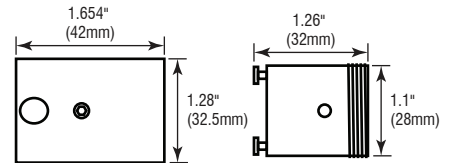

**Surface Mounts Power Feed
End and Caps Terminal End**

SUSPENDED PENDANT

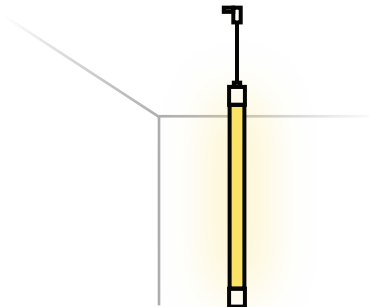

SPECIFICATIONS

Model	VN-25-SP-V-FF
Model w/ Sleeve*	VN-25-SP-V-XXX
Material	Aluminum
EC Length	1.654" (42mm)
EC Diameter	1.24" (31.5mm)
SP Length	2.677" (68mm)
SP Diameter	1.24" (31.5mm)
Internal Diameter	1" (25.4mm)
Cable Length	Variable, 6ft max

*Polycarbonate sleeve (not pictured) is required for Vine to hang perfectly vertical. XXX is the sleeve length in inches.

EC—End Cap

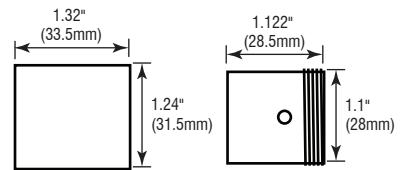

SP—Suspended Pendant

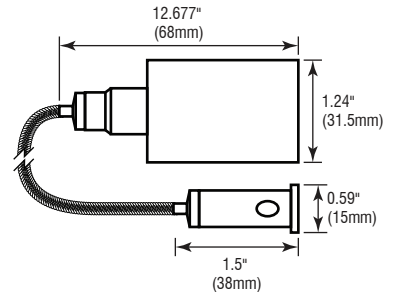

**Suspends Power Feed
End and Caps Terminal End**