

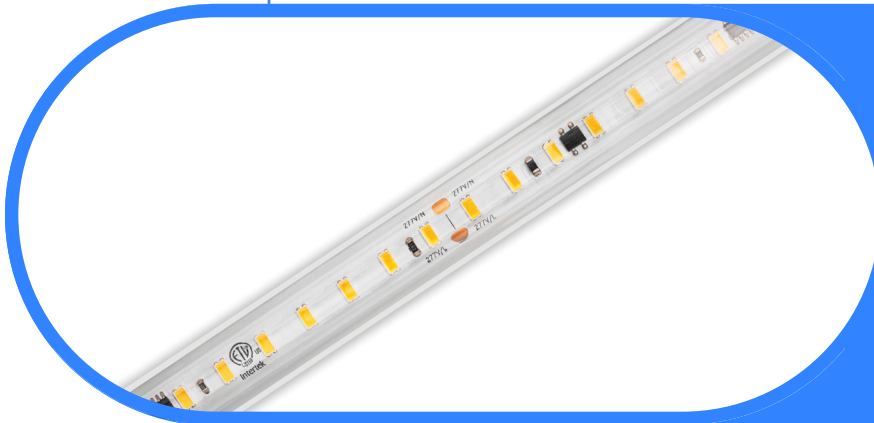

Complete Specification Sheet

Orex™ 277V Static White

LINEAR
LED



Orex™ 277V Static White

Line Voltage Linear LED Tape



Specifications

Category	Linear LED
Series	Orex 277V
Family	Static White
Watts Per Foot	250 lm/ft = 3W/ft, 500 lm/ft = 6W/ft
Environment	IP65
CRI	90+
CCT Options	2400K, 2700K, 3000K, 3500K, 4000K, 5000K, 6500K
Input Voltage	277V AC
Width	0.89in (22.7mm)
Height	0.44in (11.3mm)
Max Run Length	150ft
Cut Intervals	6.00in (152.4mm)
Beam Angle	120°
Operating Temp.	-4°F (-20°C) to 107°F (42°C)
Dimming Options	0-10V (with LCX-1041), Triac, and ELV

Features

- 277V Line Voltage
- Integral AC/DC Rectifier
- 150ft Continuous Max Run Length
- ETL Verified to UL-1598 Luminaires Standard
- Dimmable Using 0-10V (with LCX-1042) Triac, and ELV

Description

Skip the power supply and connect Orex 277V directly to your 277VAC source! With two different output options, a longer max run length, a variety of CCTs, and 0-10V control (with LCX-1042)1, Orex 277V is the perfect solution for your next project.

Dimensions

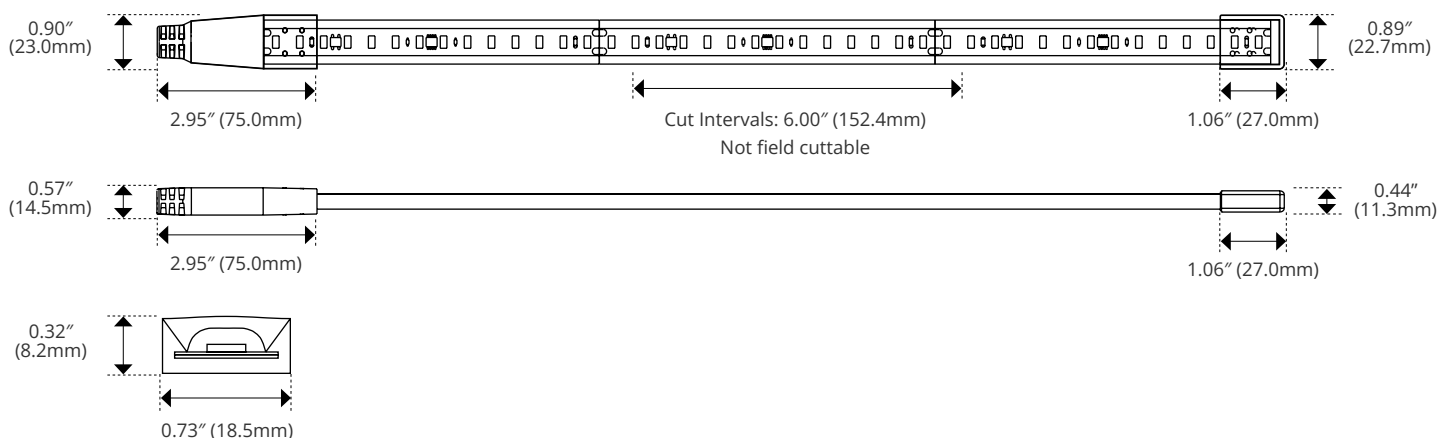

Kelvix reserves the right to update the product specifications at any time. Field modifications will void ETL listing and warranty.

Conforms to ANSI/UL Standard 2108
Certified to CAN/CSA Standard C22.2 No. 250.2

Fixture Type _____

Project Name _____

Location _____



Product Code Builder

Orex™ 277V Static White

Product Code Builder

Example: RX277-27K-250-HW72-277V-XX

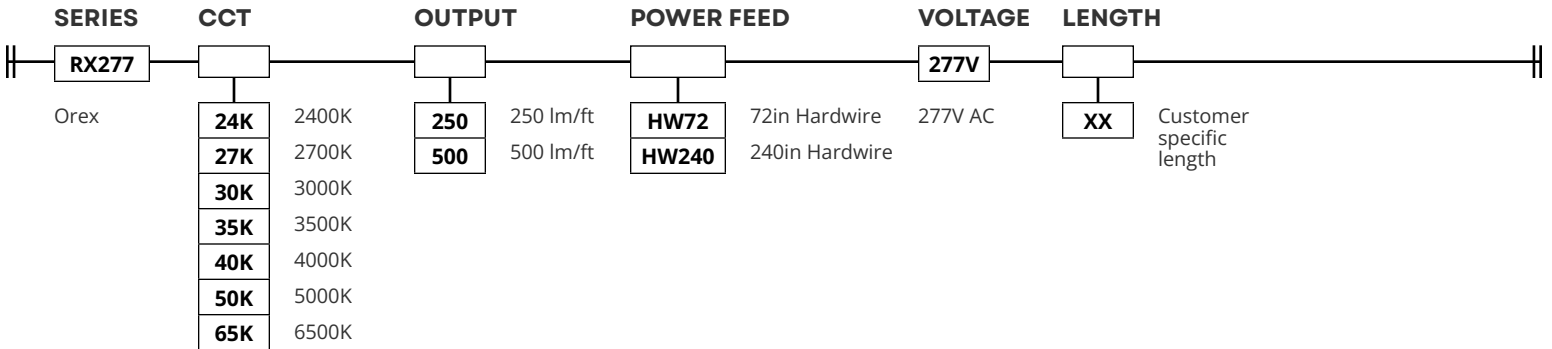

PRODUCT DATA

	Configuration	2400K	2700K	3000K	3500K	4000K	5000K	6500K
Orex 250	Tape Only	114	163	166	171	174	179	181
	Tape, Channel, & Flat Lens	87	98	100	103	105	108	109
	Tape, Channel, & Square Lens	86	97	99	102	104	107	108
Orex 500	Tape Only	345	389	397	409	417	428	432
	Tape, Channel, & Flat Lens	205	231	236	243	248	255	257
	Tape, Channel, & Square Lens	219	247	252	259	264	272	275
% Difference from 30K	--	87%	98%	100%	103%	105%	108%	109%

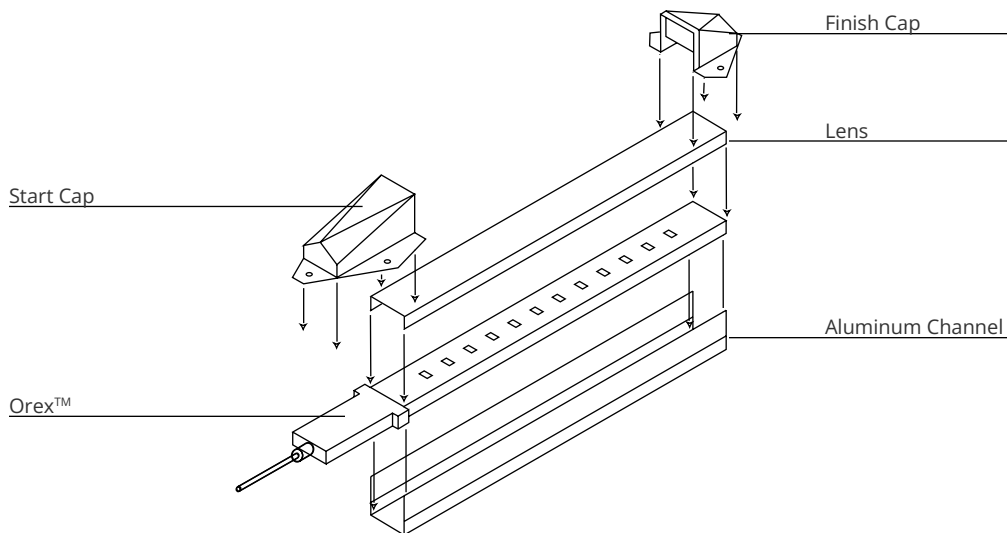

Kelvix reserves the right to update the product specifications at any time. Field modifications will void ETL listing and warranty.
 Conforms to ANSI/UL Standard 2108
 Certified to CAN/CSA Standard C22.2 No. 250.2

Fixture Type _____
 Project Name _____
 Location _____



Product Details

Orex™ 277V Static White

Photometric 4000K

250 LM/FT 4000K

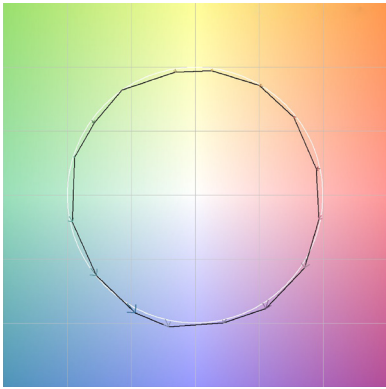

Photometric 3000K

250 LM/FT TAPE ONLY

250 LM/FT WITH FLAT LENS

250 LM/FT WITH SQUARE LENS

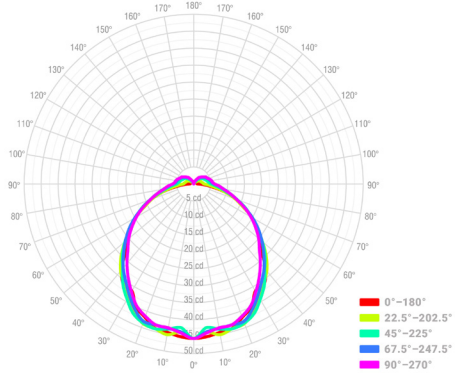
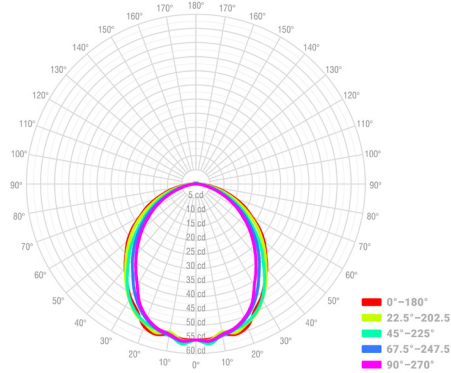
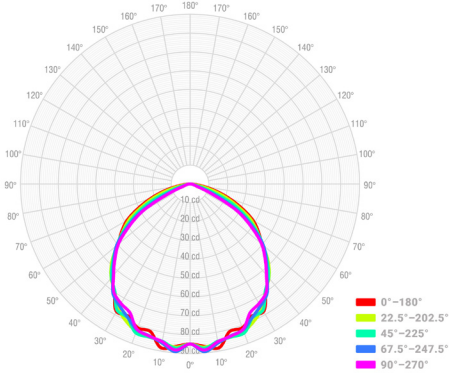

500 LM/FT TAPE ONLY

500 LM/FT WITH FLAT LENS

500 LM/FT WITH SQUARE LENS

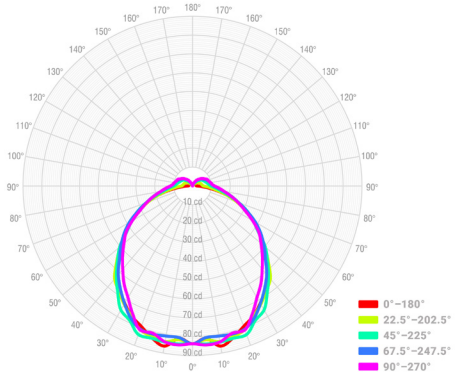
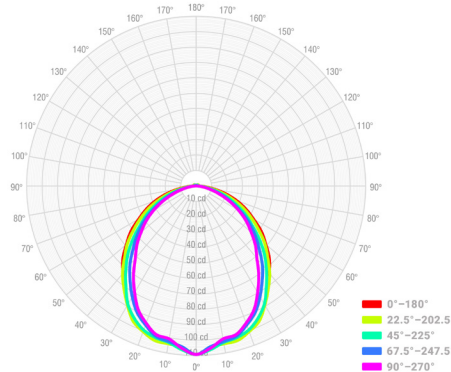
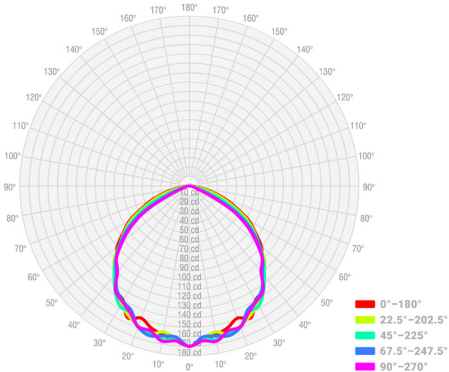

Kelvix reserves the right to update the product specifications at any time. Field modifications will void ETL listing and warranty.
Conforms to ANSI/UL Standard 2108
Certified to CAN/CSA Standard C22.2 No. 250.2

Fixture Type _____

Project Name _____

Location _____



Aluminum Mounting Options

Orex™ 277V Static White

Mounting Options

IMAGE

Aluminum mounting options are not compatible with plastic mounting options

Flat Aluminum Channel

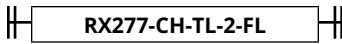

Length	78.74in (2m)
Width	0.93in (23.5mm)
Height	0.83in (21.1mm)
Internal Width	0.76in (19.4mm)
Light Transmission	60%

Includes 1 set of end caps, 5 mounting clips, and flat pixel free lens.

DIMENSIONS

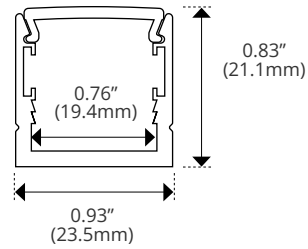

Flat Channel End Cap

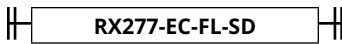

Start Cap Length	4.17in (106.0mm)
Finish Cap Length	1.93in (49.0mm)
Width	1.89in (48.0mm)
Height	0.91in (23.0mm)

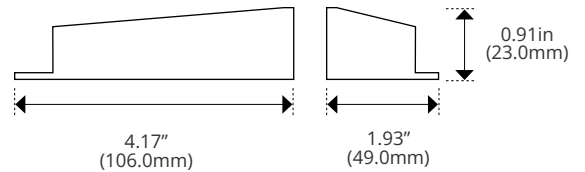

Square Aluminum Channel

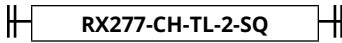

Length	78.74in (2m)
Width	0.93in (23.5mm)
Height	1.22in (31.0mm)
Internal Width	0.76in (19.4mm)
Light Transmission	61%

Includes 1 set of end caps, 5 mounting clips, and flat pixel free lens.

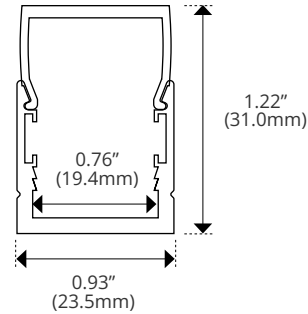

Square Channel End Cap

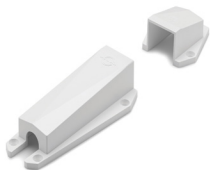

Start Cap Length	4.17in (106.0mm)
Finish Cap Length	1.93in (49.0mm)
Width	1.83in (46.6mm)
Height	1.30in (33.0mm)

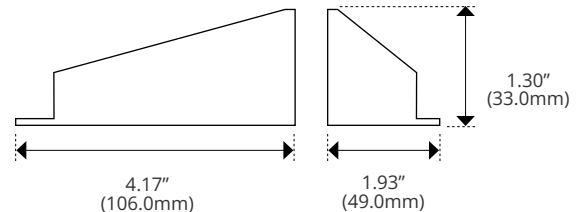

Aluminum Clip



Length	1.02in (25.85mm)
Width	0.79in (20.0mm)
Height	0.31in (7.86mm)

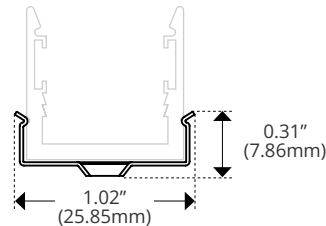

Kelvix reserves the right to update the product specifications at any time. Field modifications will void ETL listing and warranty.

Conforms to ANSI/UL Standard 2108
Certified to CAN/CSA Standard C22.2 No. 250.2

Fixture Type _____

Project Name _____

Location _____



Plastic Mounting Options

Orex™ 277V Static White

Mounting Options

IMAGE

Plastic mounting options are not compatible with aluminum mounting options

SPECIFICATIONS

DIMENSIONS

Plastic Mounting Base



RX277-CH-PL-2M	
Length	78.74in (2m)
Width	0.89in (22.5mm)
Height	0.51in (13.0mm)

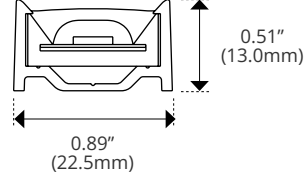

Mounting Clip



RX277-CLP-F1-PAK-P	
Length	0.71in (18.0mm)
Width	0.94in (23.8mm)
Height	0.44in (14.3mm)

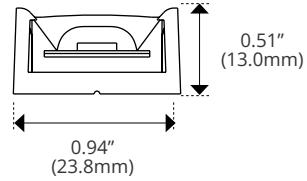

Pack of 10 Units

45° Mounting Clip



RX277-CLP-A1-PAK-P	
Length	0.79in (20.0mm)
Width	1.07in (27.3mm)
Height	0.95in (24.2mm)

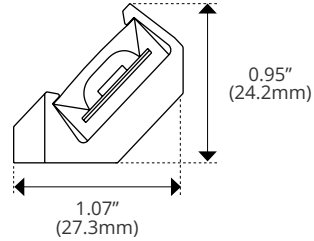

Pack of 10 Units

90° Mounting Clip



RX277-CLP-V1-PAK-P	
Length	0.62in (15.8mm)
Width	1.06in (27.0mm)
Height	0.79in (20.0mm)

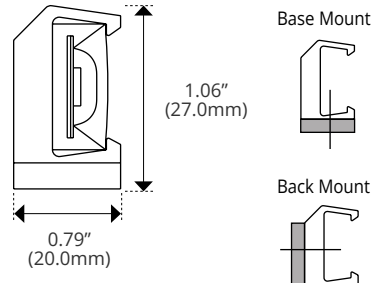

Pack of 10 Units

Kelvix reserves the right to update the product specifications at any time. Field modifications will void ETL listing and warranty.
 Conforms to ANSI/UL Standard 2108
 Certified to CAN/CSA Standard C22.2 No. 250.2

Fixture Type _____

Project Name _____

Location _____



Power Feed Details

Orex™ 277V Static White

Factory Molded Power Feeds and Connectors

IMAGE

Hardwire Power Feed



DETAILS

RX277-HWP-72-IM | 72in (6.0ft)

RX277-HWP-240-IM | 240in (20.0ft)

DIAGRAM

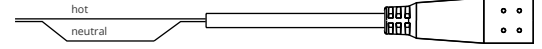

Jump Cables



SERIES	TYPE	LENGTH	TYPE
RX277	JP		IM
Orex	Jumper Cable	6	Injection Mold
		24	
		48	
		6in (0.5ft)	
		24in (2.0ft)	
		48in (4.0ft)	

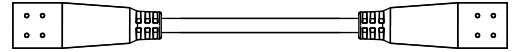



Power Details

Orex™ 277

Power Supply Details

DETAILS



SPECIFICATION

LCX-1042	
Model	LCX-1042
Input Voltage	277V AC
Output Voltage	277V AC
Input Max Amp	4A
Output	1000W Max
Front Panel Dimensions	4.8in (121.9mm) × 4.8in (121.9mm)
Depth	1.87"
Ambient Temperature	104°F Max

1 Channel × 1000W Dimmer @ 277V AC
 Mounts to Any 2-Gang (or 4 Square) J-Box
 0-10V Control Inputs

WIRING

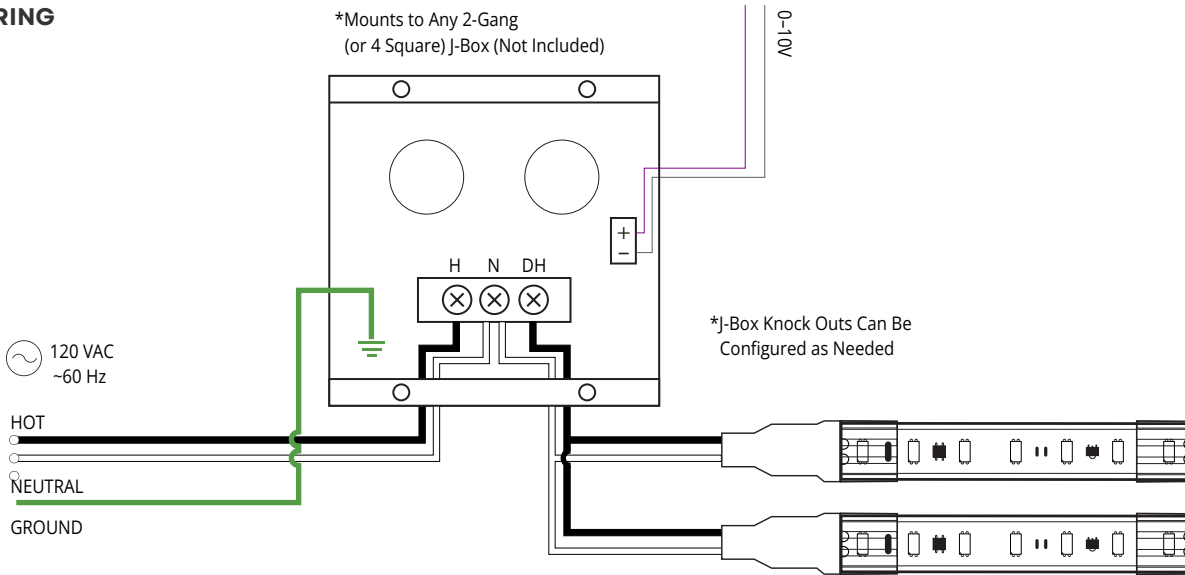

Kelvix reserves the right to update the product specifications at any time. Field modifications will void ETL listing and warranty.
 Conforms to ANSI/UL Standard 2108
 Certified to CAN/CSA Standard C22.2 No. 250.2

Fixture Type _____
 Project Name _____
 Location _____