

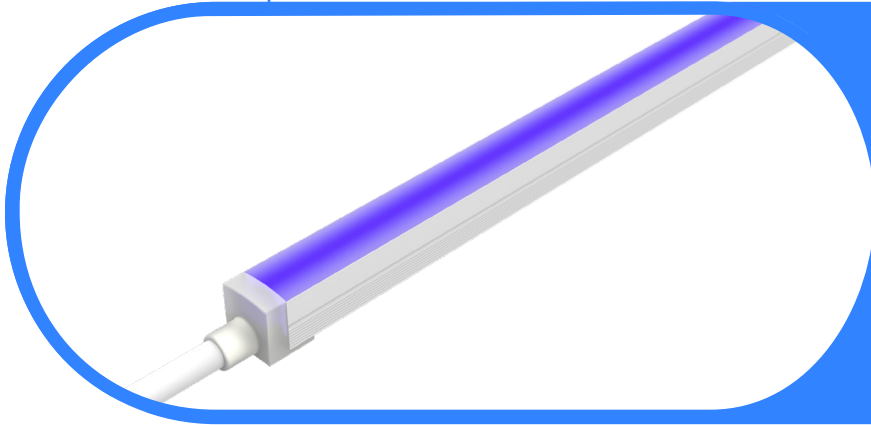

Complete Specification Sheet

Endurawave Narrow RGBW

FLEXIBLE
NEON



Endurawave Narrow RGBW

0.79" x 0.79" Narrow View

Flexible Neon



Specifications

| | |
|------------------------------------|--|
| Category | Flexible Neon |
| Series | Endurawave Narrow |
| Family | RGBW |
| Watts per Foot | 5.95 W |
| Environment | IP67/IP68 |
| Color Options | RGBW-27K, RGBW-30K, RGBW-40K, RGBW-60K |
| Input Voltage | 24V DC |
| Width | 0.79in (20mm) |
| Height | 0.79in (20mm) |
| Max Run Length | 16.4ft (5m) |
| Cut Intervals | 1.64in (41.67mm) |
| Feed Orientation | Bottom Feed, End Feed, Side Right, Side Left |
| Material | Silicone |
| Bend Diameter | V: 11.81" (300mm) / H: 31.50" (800mm) |
| Bend Direction | 3D Bend (Horizontal and Vertical) |
| Beam Angle | 115° |
| Lumens per Foot | 169-175 lm/ft |
| Viewing Angle | Narrow |
| Life Expectancy | 50,000 Hour Life |
| Storage Temp. | -4°F (-20°C) to 158°F (70°C) |
| Operating Temp. | -4°F (-20°C) to 140°F (60°C) |
| Dimming Options¹ | PWM, DMX |

¹Specific dimming protocol dependent upon driver compatibility.

Features

- Strong Tensile Strength
- 3D Bending Flexibility
- Wide Range of Controls Options
- 50,000 Hour Life
- Silicone Jacket with IP67 or IP68 Options
- UL-Listed for Indoor and Outdoor Use
- For Use with 24V Power Supplies

Description

Endurawave revolutionizes flexibility with its rigid PCB encased in a protective shell, allowing seamless bending and twisting without compromising LEDs or components. Reinforced by durable steel wires, it ensures long daisy-chain connections with superior tensile strength and 3D bending functionality.

Application



Kelvix reserves the right to update the product specifications at any time. Field modifications will void UL listing and warranty. Conforms to ANSI/UL Standard 2108. Certified to CAN/CSA Standard C22.2 No. 250.2 5% tolerance for all listed data

Fixture Type _____

Project Name _____

Location _____



Product Code Builder

Endurawave Narrow RGBW

FLEXIBLE
NEON

Product Code Builder

Example: ENN-CC-RGBW2-24V-E67-1-10

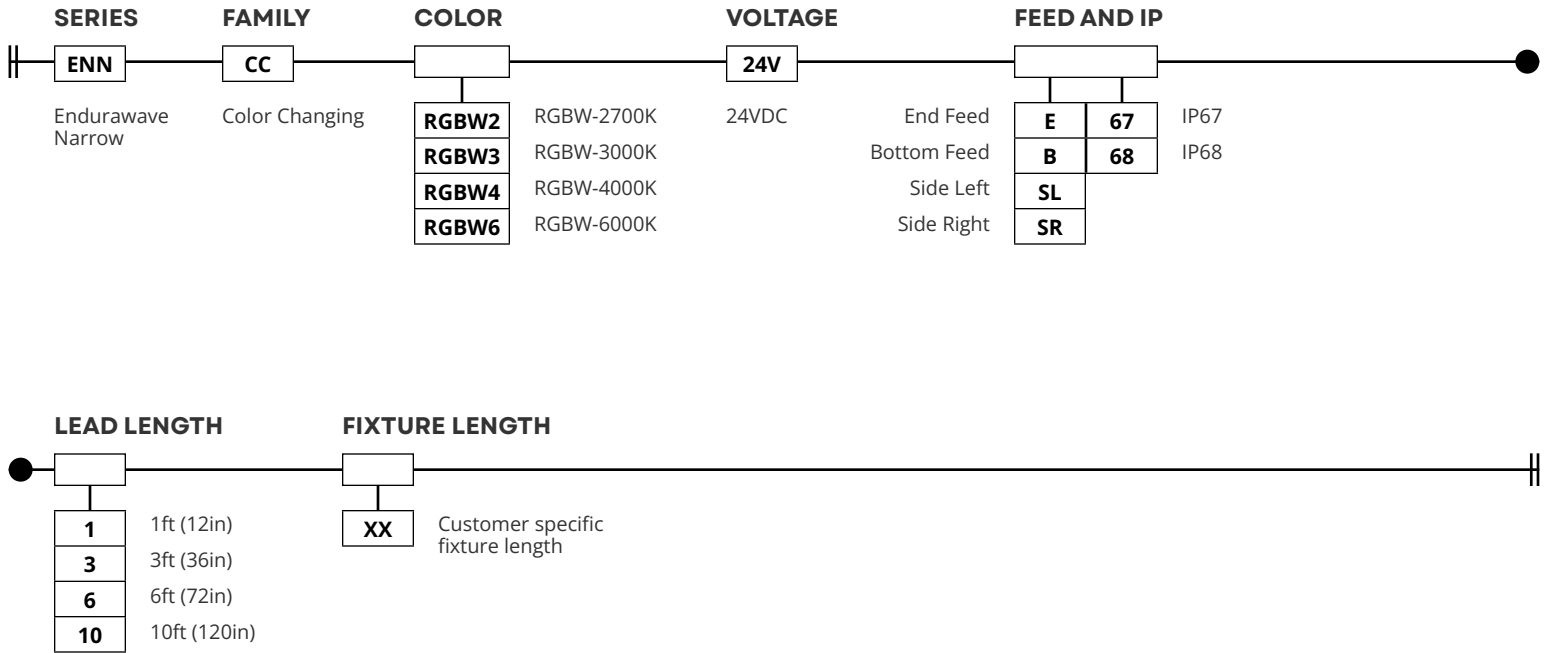

| Color | Lumens per Foot |
|-------|-----------------|
| RGBW2 | 169 lm |
| RGBW3 | 169 lm |
| RGBW4 | 181 lm |
| RGBW6 | 175 lm |

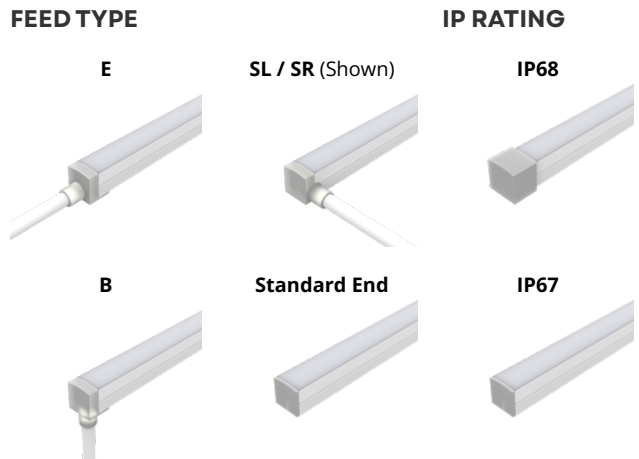

| Description | Wire Gauge |
|---------------------------------|------------------------|
| 5 Conductor Leader Cable (1ft) | 2 x 18AWG 3 x 22AWG |
| 5 Conductor Leader Cable (3ft) | 2 x 18AWG 3 x 22AWG |
| 5 Conductor Leader Cable (6ft) | 2 x 18AWG 3 x 22AWG |
| 5 Conductor Leader Cable (10ft) | 2 x 18AWG 3 x 22AWG |

Kelvix reserves the right to update the product specifications at any time. Field modifications will void UL listing and warranty. Conforms to ANSI/UL Standard 2108. Certified to CAN/CSA Standard C22.2 No. 250.2 5% tolerance for all listed data

Fixture Type _____

Project Name _____

Location _____



Product Details

Endurawave Narrow RGBW

FLEXIBLE
NEON

Photometric

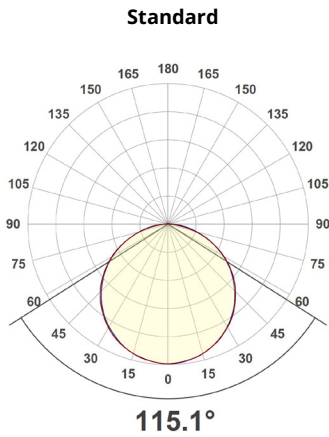

Performance

| Color | CRI | Lumens per Foot | Input Voltage | W/ft |
|-------|-------------|-----------------|---------------|--------|
| RGBW2 | 90+ (White) | 169 lm | 24VDC | 5.95 W |
| RGBW3 | | 169 lm | | |
| RGBW4 | | 181 lm | | |
| RGBW6 | | 175 lm | | |

Leader Cables

| Description | Ordering Code | Length | Wire Gauge |
|---------------------------------|---------------|--------|------------------------|
| 5 Conductor Leader Cable (1ft) | 1 | 1 ft | 2 x 18AWG 3 x 22AWG |
| 5 Conductor Leader Cable (3ft) | 3 | 3 ft | 2 x 18AWG 3 x 22AWG |
| 5 Conductor Leader Cable (6ft) | 6 | 6 ft | 2 x 18AWG 3 x 22AWG |
| 5 Conductor Leader Cable (10ft) | 10 | 10 ft | 2 x 18AWG 3 x 22AWG |

Dimensions

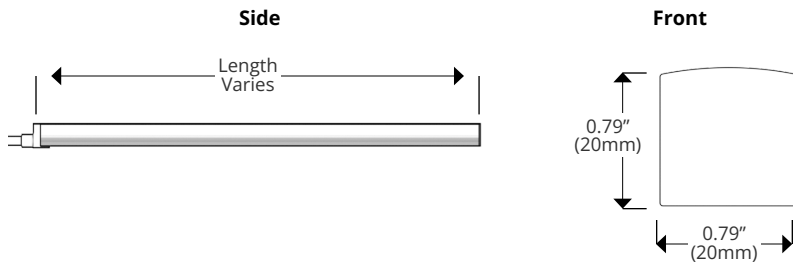

Bend Direction

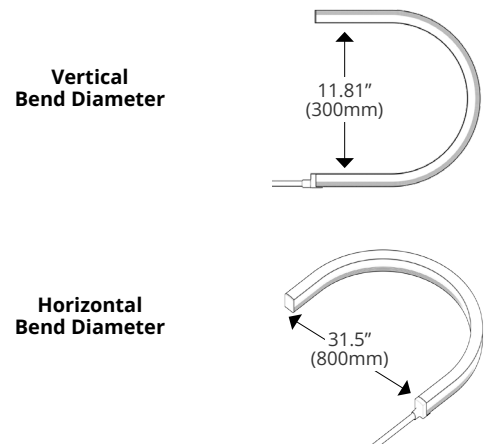

Kelvix reserves the right to update the product specifications at any time. Field modifications will void UL listing and warranty. Conforms to ANSI/UL Standard 2108. Certified to CAN/CSA Standard C22.2 No. 250.2 5% tolerance for all listed data

Fixture Type _____

Project Name _____

Location _____



End Feed Options

Endurawave Narrow Series

FLEXIBLE
NEON

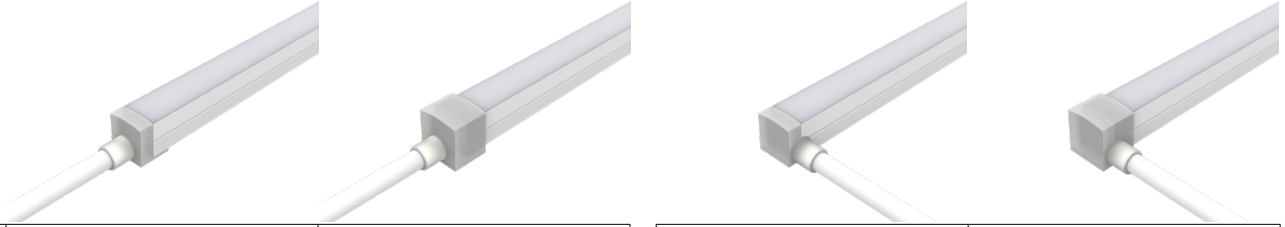

| | IP67 | IP68 |
|---------------------|-----------------|-----------------|
| Type | End Feed (E) | |
| Length Adder | 0.31in (8mm) | 0.31in (8mm) |
| Length | 0.69in (17.5mm) | 0.98in (25mm) |
| Width | 0.85in (21.5mm) | 0.91in (23.2mm) |
| Height | 0.85in (21.5mm) | 0.91in (23.2mm) |

| | IP67 | IP68 |
|---------------------|---|-----------------|
| Type | Side Feed Left (SL) / Side Feed Right (SR) (SR Shown) | |
| Length Adder | 0.31in (8mm) | 0.31in (8mm) |
| Length | 0.71in (18mm) | 0.98in (25mm) |
| Width | 0.85in (21.5mm) | 0.91in (23.2mm) |
| Height | 0.85in (21.5mm) | 0.91in (23.2mm) |

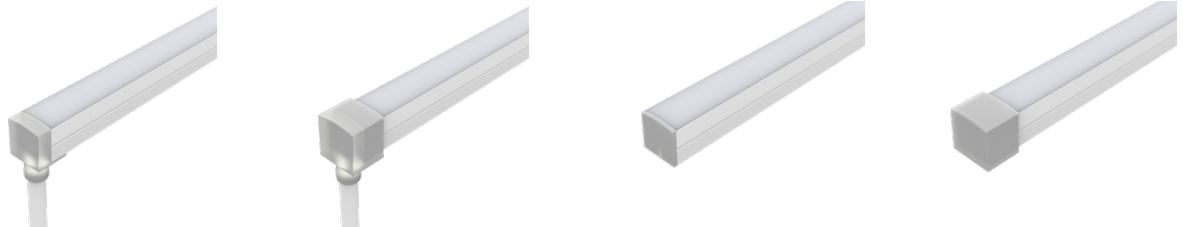
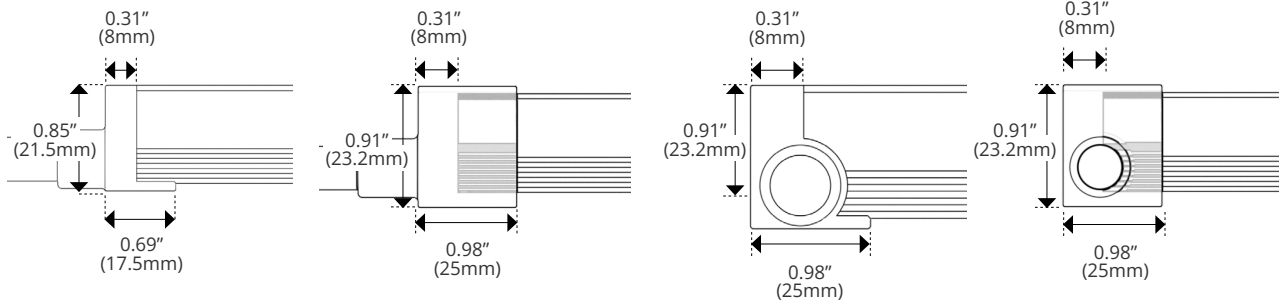

| | IP67 | IP68 |
|---------------------|-----------------|-----------------|
| Type | Back Feed (B) | |
| Length Adder | 0.31in (8mm) | 0.31in (8mm) |
| Length | 0.71in (18mm) | 0.98in (25mm) |
| Width | 0.85in (21.5mm) | 0.91in (23.2mm) |
| Height | 0.85in (21.5mm) | 0.91in (23.2mm) |

| | IP67 | IP68 |
|---------------------|---------------|-----------------|
| Type | End Cap | |
| Length Adder | 0.08in (2mm) | 0.08in (2mm) |
| Length | 2mm | 0.79in (20mm) |
| Width | 0.79in (20mm) | 0.91in (23.2mm) |
| Height | 0.79in (20mm) | 0.91in (23.2mm) |

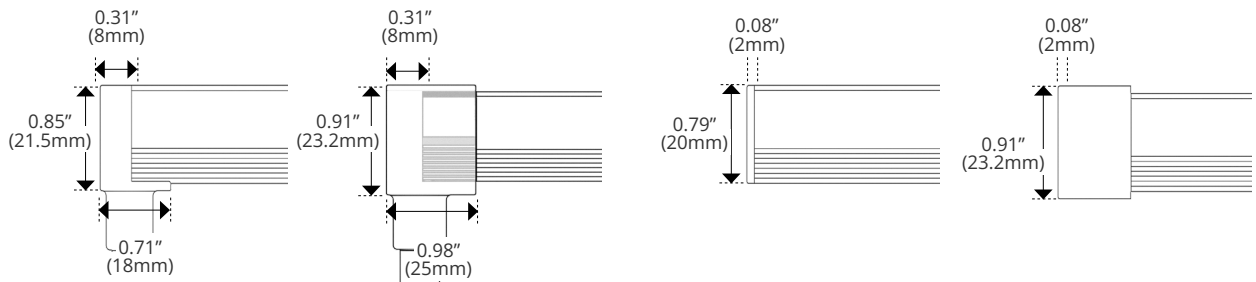

Kelvix reserves the right to update the product specifications at any time. Field modifications will void UL listing and warranty. Conforms to ANSI/UL Standard 2108. Certified to CAN/CSA Standard C22.2 No. 250.2 5% tolerance for all listed data

Fixture Type _____

Project Name _____

Location _____



Mounting Options

Endurawave Narrow Series

FLEXIBLE
NEON

IMAGE

SPECIFICATIONS

MOUNTING DIMENSIONS

DIMENSIONS WITH PRODUCT

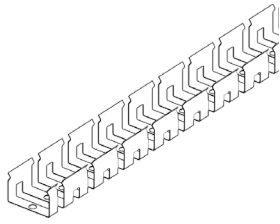

| ENN-CH-SS-FLX-1M | |
|------------------|-------------------|
| Length | 39.37in (1,000mm) |
| Width | 0.85in (21.7mm) |
| Height | 0.54in (13.7mm) |

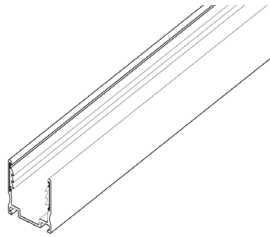
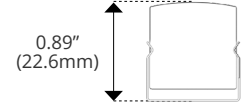
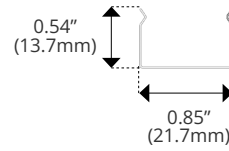

| ENN-CH-AL-SR-2M | |
|-----------------|-------------------|
| Length | 78.74in (2,000mm) |
| Width | 0.98in (25mm) |
| Height | 0.91in (23mm) |

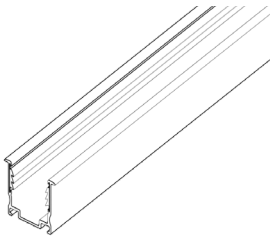
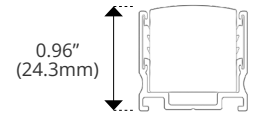
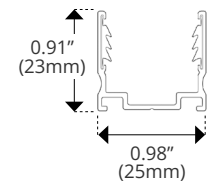

| ENN-CH-AL-SR-RC-2M | |
|--------------------|-------------------|
| Length | 78.74in (2,000mm) |
| Width | 1.18in (30mm) |
| Height | 0.91in (23mm) |

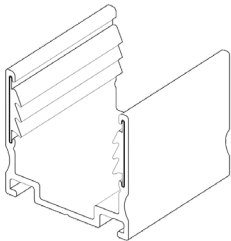
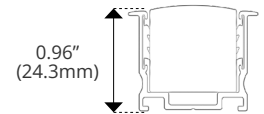
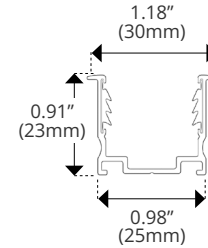

| ENN-CLP-AL-SR | |
|---------------|---------------|
| Length | 1.38in (35mm) |
| Width | 0.98in (25mm) |
| Height | 0.91in (23mm) |

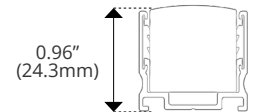
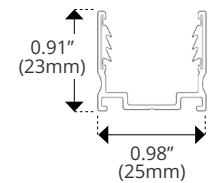

Kelvix reserves the right to update the product specifications at any time. Field modifications will void UL listing and warranty. Conforms to ANSI/UL Standard 2108. Certified to CAN/CSA Standard C22.2 No. 250.2 5% tolerance for all listed data

Fixture Type _____

Project Name _____

Location _____