

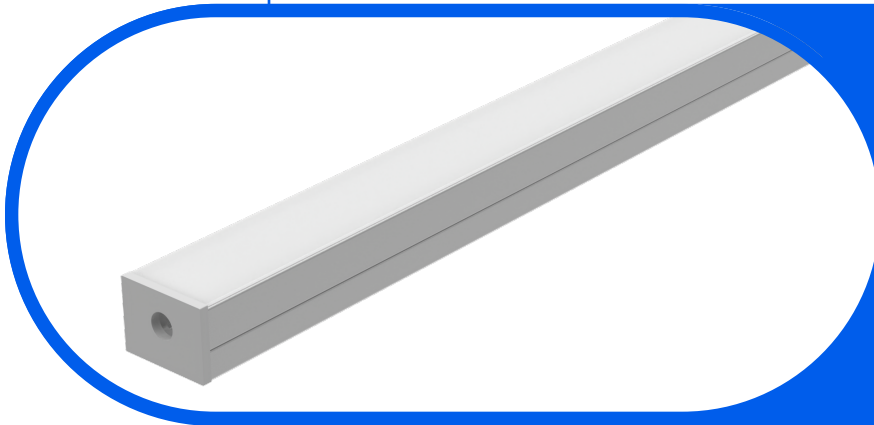

Complete Specification Sheet

Easy Spec 409 Static White

EASY
SPEC



Easy Spec 409 Static White (Indoor)

Easy Spec™: components to easily specify a fixture



Specifications

Category	Easy Spec
Series	Easy 409
Family	Static White
Watts per Foot	0.7 - 14.4 W
IP Rating	IP20
CRI	90+, 95+
Diodes	U2835
Binning Tolerance	1 SDCM, 2 SDCM, 3 SDCM
CCT Options	1800K - 6500K
Input Voltage	24V DC
Width	0.68in (18.0mm)
Height	0.50in (13.0mm)
Max Run Length	7 - 46ft (2.1 - 14m)
Material	Aluminum
Beam Angle	62.2°
Lumens per Foot	63 - 1475 lm/ft
Storage Temp.	-4°F (-20°C) to 158°F (70°C)
Operating Temp.	-4°F (-20°C) to 140°F (60°C)
Dimming Options	Triac, ELV, 0-10V, DMX

Features

- Field Serviceable Light Source & Engine
- Dimmable to 0.1%
- Beam Angles As Narrow As 22.5°
- 5/10 Year Warranty for LED Strip / Drivers
- Optional Assembly Available For Any Fixtures Up to 2m (6.56ft)
- Diode Imaging Free

Description

The Easy Spec series is designed for convenience and versatility, allowing you to quickly specify our standard Tape and Channel pairs with just one part number. Products arrive as individual components, providing your installation team the advantage of customizing lengths and configurations on-site for an optimal fit. Assembly services are available upon request.

Kelvix reserves the right to update the product specifications at any time. To maintain warranty, field modifications must follow approved Kelvix installation instruction.
 Conforms to ANSI/UL Standard 2108
 Certified to CAN/CSA Standard C22.2 No. 250.2

Fixture Type _____

Project Name _____

Location _____



Product Code Builder

Easy Spec 409 Static White

Product Code Builder

Example: EZ-409-I-U1-18K-100-C-P-A

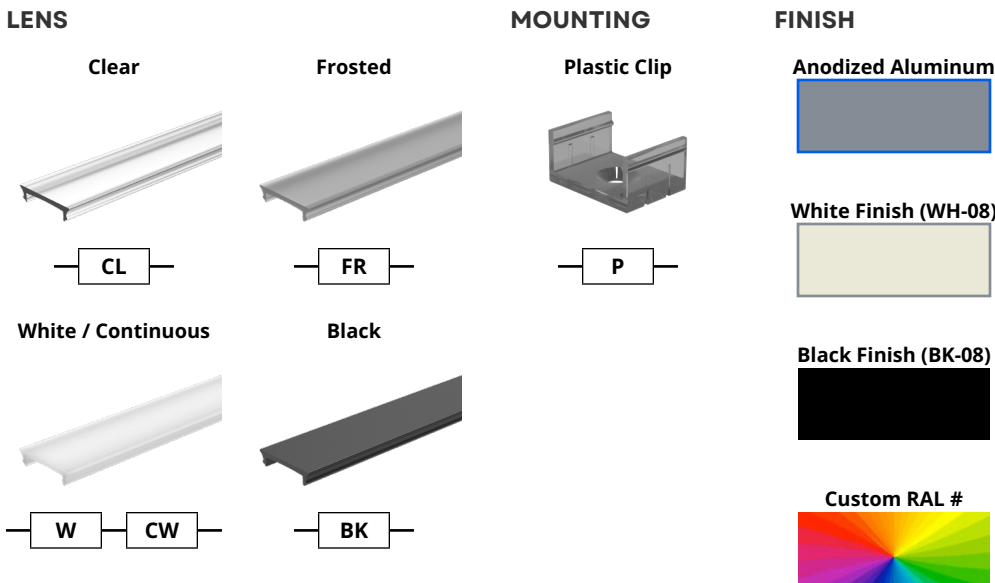
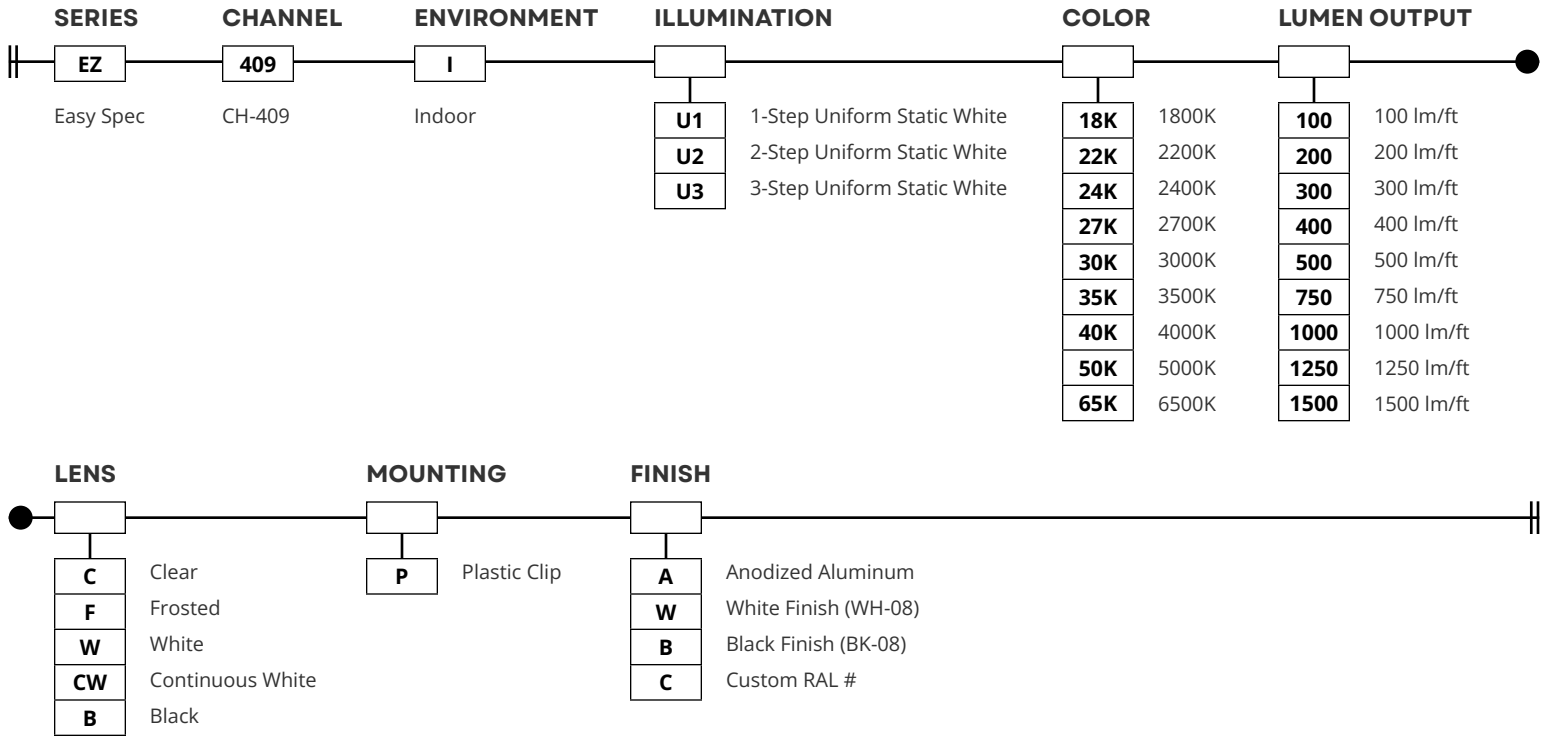

Kelvix reserves the right to update the product specifications at any time. To maintain warranty, field modifications must follow approved Kelvix installation instruction.
 Conforms to ANSI/UL Standard 2108
 Certified to CAN/CSA Standard C22.2 No. 250.2

Fixture Type _____

Project Name _____

Location _____



Assembly Details

Easy Spec 409 Static White

Components

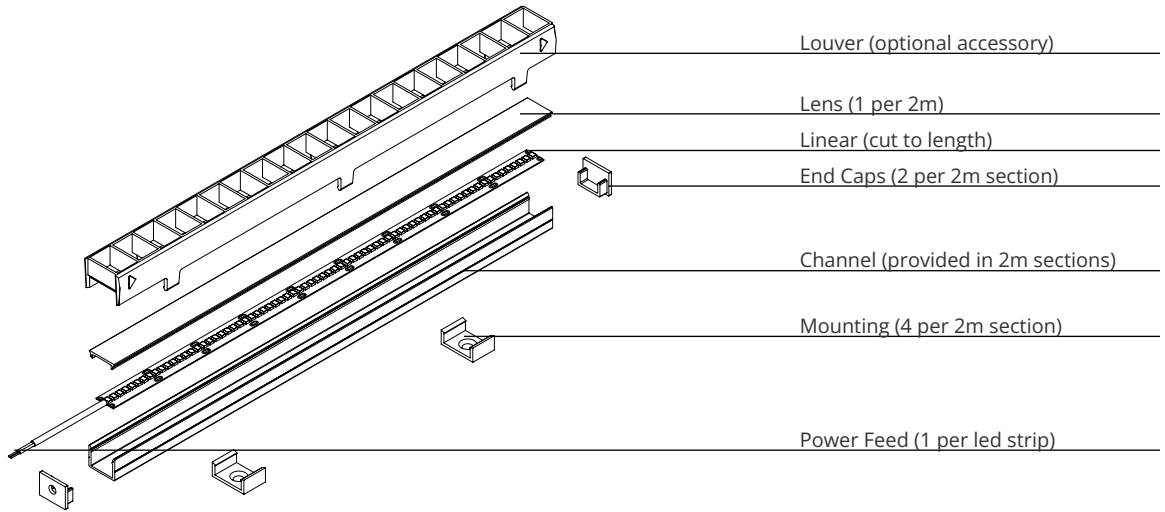

Channel

TYPE

409

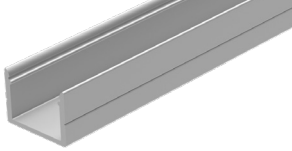

DESCRIPTION

CH-409-2M	
Width	0.68in (18.0mm)
Internal Width	0.56in (15.0mm)
Height	0.50in (13.0mm)

DIMENSIONS

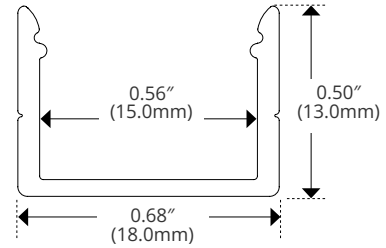

Linear

Uniform Static White (Indoor)



Diode	2835
Width	0.47" (12.0mm)
Cut Intervals	1.31" (33.3mm)
Height	0.07" (1.8mm)

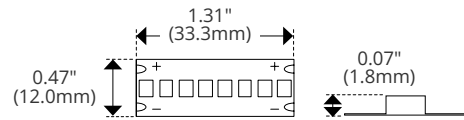

Kelvix reserves the right to update the product specifications at any time. To maintain warranty, field modifications must follow approved Kelvix installation instruction.
 Conforms to ANSI/UL Standard 2108
 Certified to CAN/CSA Standard C22.2 No. 250.2

Fixture Type _____

Project Name _____

Location _____



Lens Details

Easy Spec 409 Static White

TYPE

White / Continuous



DESCRIPTION

White | CH-LNS-409-WH-2M

Continuous | CH-LNS-409-WH-25M

Material	Polycarbonate
Transmission	53%
Width	0.62" (15.8mm)
Height	0.62" (15.8mm)

BEAM ANGLE

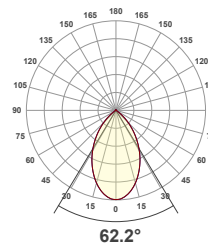

DIMENSIONS

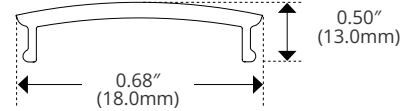

Frosted



CH-LNS-409-FR-2M

Material	Polycarbonate
Transmission	85%
Width	0.62" (15.8mm)
Height	0.62" (15.8mm)

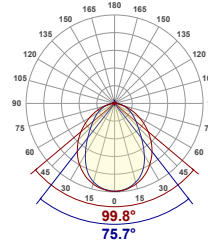

Clear



CH-LNS-409-CL-2M

Material	Polycarbonate
Transmission	96%
Width	0.62" (15.8mm)
Height	0.62" (15.8mm)

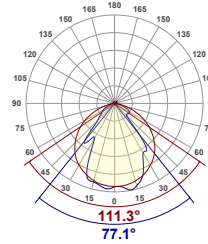

Black

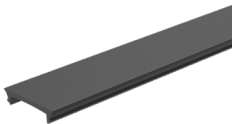

CH-LNS-409-BK-2M

Material	Polycarbonate
Transmission	12%
Width	0.62" (15.8mm)
Height	0.62" (15.8mm)

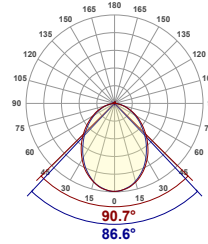

ACCESSORIES SOLD SEPARATELY

Louver



CH-409-LV-BK-1FT

UGR	<13
Length	12.05" (306.03mm)
Width	0.96" (24.38mm)
Height	1.06" (26.92mm)
Height w/ Clip	1.1" (27.68mm)

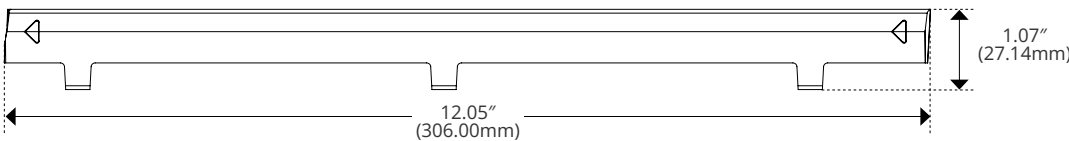
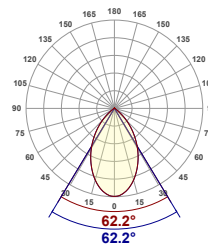

Kelvix reserves the right to update the product specifications at any time. To maintain warranty, field modifications must follow approved Kelvix installation instruction.
 Conforms to ANSI/UL Standard 2108
 Certified to CAN/CSA Standard C22.2 No. 250.2

Fixture Type _____

Project Name _____

Location _____



Mounting Details

Easy Spec 409 Static White

TYPE

Plastic Clip

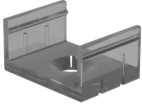

DESCRIPTION

CH-409-PAK-P

Length	0.59in (15.0mm)
Width	0.62in (16.0mm)
Height	0.62in (16.0mm)

DIMENSIONS

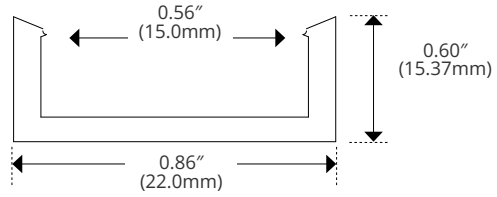

Fixture Type _____
 Project Name _____
 Location _____



Lumen and Power Details

Easy Spec 409 Static White

DELIVERED LUMENS (1 AND 2-STEP)

CCT	Lens	100 (lm/ft)	200 (lm/ft)	300 (lm/ft)	400 (lm/ft)	500 (lm/ft)	750 (lm/ft)	1000 (lm/ft)	1250 (lm/ft)	1500 (lm/ft)
1800K	White	38	86	134	177	202	275	349	449	529
2200K		46	104	162	214	245	324	412	529	623
2400K		47	108	168	222	254	343	435	559	659
2700K		49	112	174	229	262	362	459	590	695
3000K		53	121	189	249	285	377	479	615	724
3500K		63	144	225	296	339	411	522	670	789
4000K		56	129	200	264	302	407	517	664	782
5000K		57	130	202	267	305	414	526	676	796
6500K		57	131	204	269	308	418	531	682	804
1800K	Frosted	48	110	172	226	259	357	453	582	686
2200K		59	134	208	274	313	420	534	686	807
2400K		61	138	215	284	325	445	565	725	854
2700K		63	143	222	293	335	469	595	765	902
3000K		68	155	242	318	365	488	621	797	939
3500K		81	185	288	379	434	533	676	869	1023
4000K		72	165	256	338	386	527	670	861	1014
5000K		73	166	259	341	390	537	682	877	1033
6500K		73	168	261	344	394	543	689	885	1042
1800K	Clear	52	120	186	245	281	386	490	629	741
2200K		64	145	225	297	340	454	577	741	873
2400K		66	150	234	308	352	481	611	784	924
2700K		68	155	241	318	364	507	644	828	975
3000K		74	168	262	346	396	528	671	862	1015
3500K		88	201	313	412	471	576	731	940	1107
4000K		78	179	278	367	419	570	725	931	1097
5000K		79	181	281	370	423	581	738	948	1117
6500K		80	182	284	374	427	587	745	957	1127
1800K	Black	5	11	16	22	25	35	44	57	67
2200K		6	13	20	26	30	41	52	67	78
2400K		6	13	21	27	31	43	55	70	83
2700K		6	14	21	28	32	46	58	74	88
3000K		7	15	23	30	35	47	60	77	91
3500K		8	18	27	36	41	52	66	84	99
4000K		7	16	24	32	37	51	65	84	98
5000K		7	16	25	33	37	52	66	85	100
6500K		7	16	25	33	38	53	67	86	101

Kelvix reserves the right to update the product specifications at any time. To maintain warranty, field modifications must follow approved Kelvix installation instruction.
 Conforms to ANSI/UL Standard 2108
 Certified to CAN/CSA Standard C22.2 No. 250.2

Fixture Type _____
 Project Name _____
 Location _____



Lumen and Power Details

Easy Spec 409 Static White

POWER DETAILS (1 AND 2-STEP)

1 and 2 Step	Output (lm/ft)								
	100	200	300	400	500	750	1000	1250	1500
Wattage (W/ft)	0.8	1.7	2.5	3.6	4.0	6.4	8.5	11.6	14.4
Max Run Length (ft)	46	36	29	24	20	16	12	9	7
Black (lm/W)	8	9	9	8	9	7	7	7	6
White (lm/W)	67	71	76	69	71	59	56	53	50
Frosted (lm/W)	85	91	97	88	91	76	73	69	65
Clear (lm/W)	93	127	134	123	126	97	93	87	83

TM30 DATA (1 AND 2-STEP)

1250 lm/ft	CRI	Rf	Rg	R9	
1 and 2-Step	1800K	95.7	93.5	100.2	73
	2200K	95	94.1	104.2	91
	2400K	95.7	94.3	104.4	91
	2700K	95.9	95.1	103.9	98
	3000K	97.2	95.3	102.7	98
	3500K	96.7	94.9	103.5	98
	4000K	97.3	94.9	102.5	97
	5000K	96.4	95.1	103.8	97
	6500K	96.9	94.2	102.5	97

Kelvix reserves the right to update the product specifications at any time. To maintain warranty, field modifications must follow approved Kelvix installation instruction.
 Conforms to ANSI/UL Standard 2108
 Certified to CAN/CSA Standard C22.2 No. 250.2

Fixture Type _____

Project Name _____

Location _____



Lumen and Power Details

Easy Spec 409 Static White

DELIVERED LUMENS (3-STEP)

CCT	Lens	100 (lm/ft)	200 (lm/ft)	300 (lm/ft)	400 (lm/ft)	500 (lm/ft)	750 (lm/ft)	1000 (lm/ft)	1250 (lm/ft)	1500 (lm/ft)
1800K	White	41	73	108	150	172	211	271	355	415
2200K		58	104	155	216	246	335	430	564	660
2400K		62	112	165	230	263	361	464	609	713
2700K		65	116	172	240	274	354	454	596	697
3000K		65	118	174	242	277	376	484	634	742
3500K		66	119	176	244	279	395	507	666	779
4000K		68	122	180	252	288	403	517	679	794
5000K		71	127	187	262	299	410	527	691	809
6500K		69	125	184	257	293	399	512	672	787
1800K	Frosted	53	93	138	192	220	273	351	460	538
2200K		74	134	198	276	315	434	558	732	856
2400K		79	143	211	294	337	469	601	789	924
2700K		83	149	220	307	351	459	589	773	904
3000K		84	151	222	310	354	488	627	822	962
3500K		84	152	225	313	358	512	658	863	1010
4000K		87	156	231	322	368	522	671	880	1029
5000K		91	163	240	335	383	531	683	896	1048
6500K		89	160	235	329	375	517	664	871	1020
1800K	Clear	57	101	150	208	238	295	380	498	582
2200K		80	145	215	300	342	470	603	791	926
2400K		86	155	229	319	366	507	650	854	999
2700K		90	161	239	333	381	496	637	836	978
3000K		91	164	241	336	385	527	678	889	1040
3500K		91	165	244	339	388	554	711	933	1092
4000K		94	170	251	350	400	565	725	952	1113
5000K		98	177	260	363	416	575	738	969	1134
6500K		96	173	256	357	407	559	718	942	1103
1800K	Black	5	9	13	18	21	27	34	45	52
2200K		7	13	19	26	30	42	54	71	83
2400K		8	14	20	28	32	45	58	77	90
2700K		8	14	21	29	33	45	57	75	88
3000K		8	14	21	30	34	47	61	80	93
3500K		8	14	21	30	34	50	64	84	98
4000K		8	15	22	31	35	51	65	85	100
5000K		9	16	23	32	37	52	66	87	102
6500K		8	15	22	31	36	50	64	85	99

Kelvix reserves the right to update the product specifications at any time. To maintain warranty, field modifications must follow approved Kelvix installation instruction.
 Conforms to ANSI/UL Standard 2108
 Certified to CAN/CSA Standard C22.2 No. 250.2

Fixture Type _____
 Project Name _____
 Location _____



Lumen and Power Details

Easy Spec 409 Static White

POWER DETAILS (3-STEP)

3 Step	Output (lm/ft)								
	100	200	300	400	500	750	1000	1250	1500
Wattage (W/ft)	0.7	1.3	2.0	2.6	3.4	4.4	5.6	7.2	8.6
Max Run Length (ft)	46	30	25	22	19	17	14	11	11
Black (lm/W)	11	11	11	11	10	11	11	11	11
White (lm/W)	93	91	87	93	81	86	86	88	86
Frosted (lm/W)	119	116	111	119	104	111	112	114	112
Clear (lm/W)	130	140	135	145	126	138	139	142	139

TM30 DATA (3-STEP)

1250 lm/ft		CRI	Rf	Rg	R9
3-Step	1800K	93.2	91.9	99.2	64
	2200K	93.6	91.2	105.2	79
	2400K	94.1	89.7	106.1	72
	2700K	94.1	92.3	105.5	94
	3000K	94.6	92.5	103.8	86
	3500K	96.7	92	100.2	80
	4000K	97.5	92	100	91
	5000K	89.7	90	103.3	49
	6500K	89	87.4	101	46

Kelvix reserves the right to update the product specifications at any time. To maintain warranty, field modifications must follow approved Kelvix installation instruction.
 Conforms to ANSI/UL Standard 2108
 Certified to CAN/CSA Standard C22.2 No. 250.2

Fixture Type _____

Project Name _____

Location _____



Power Supply Details

Easy Spec

TYPE

DESCRIPTION

ULV-36



ULV36	
Length	4.50" (114.3mm)
Width	2.31" (58.6mm)
Height	1.37" (34.7mm)

Voltage	24V DC
Compatible Protocols	ELV, MLV, 0-10V, Resistive, PWM
Dim Capability	5%
Wattage	36W

ULV-96-M



ULV96-M	
Length	10.75" (273.0mm)
Width	3.00" (75.8mm)
Height	1.57" (40.0mm)

Voltage	24V DC
Compatible Protocols	ELV, MLV, 0-10V, Triac
Dim Capability	0.1%
Wattage	96W

ULV-192



ULV192	
Length	11.37" (288.7mm)
Width	3.37" (85.5mm)
Height	1.37" (34.7mm)

Voltage	24V DC
Compatible Protocols	ELV, MLV, 0-10V, Resistive, PWM
Dim Capability	1%
Wattage	2x 96W

ULV-96-SC-DIM



ULV96-SC-DIM	
Length	14.96" (380.0mm)
Width	3.03" (77.0mm)
Height	2.24" (57.0mm)

Voltage	24V DC
Compatible Protocols	MLV, 0-10V
Dim Capability	0.1%
Wattage	96W

Kelvix reserves the right to update the product specifications at any time. To maintain warranty, field modifications must follow approved Kelvix installation instruction.
 Conforms to ANSI/UL Standard 2108
 Certified to CAN/CSA Standard C22.2 No. 250.2

Fixture Type _____

Project Name _____

Location _____