



Complete Specification Sheet

CH-723

Channel 723

Extruded Aluminum Mounting Channel

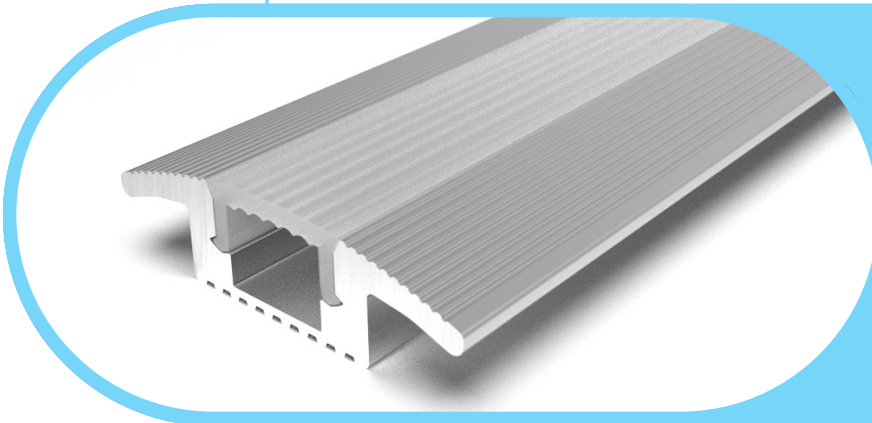

Specifications

Category	Rigid Channel
Series	Aisles
Family	CH-723
Width	1.50in (38.1mm)
Internal Width	0.40in (10.2mm)
Height	0.42in (10.8mm)
Material	Aluminum

Features

- Available in 2 Meter Sections
- Extruded Aluminum Construction
- Anodized Matte Finish
- Consult Factory for Custom Lengths & Finishes

Application

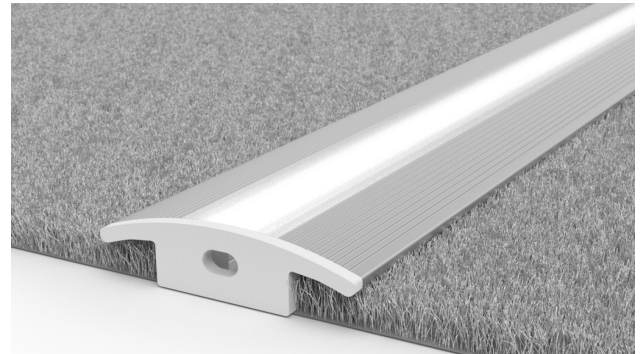

Dimensions

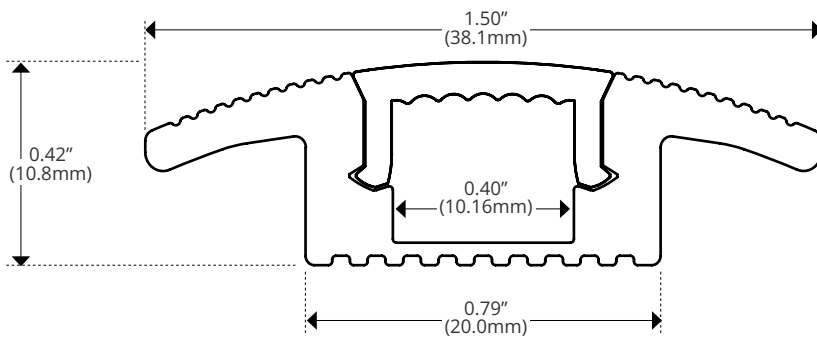

Kelvix reserves the right to update the product specifications at any time. To maintain warranty, field modifications must follow approved Kelvix installation instruction.

Fixture Type _____

Project Name _____

Location _____







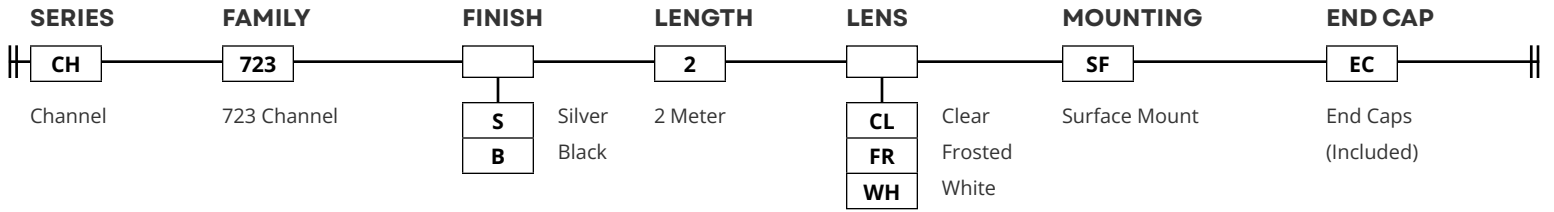

Product Code Builder

CH-723

Product Code Builder

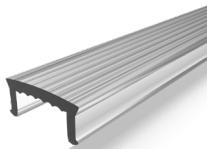
Example: CH-723-S-2-CL-SF-EC

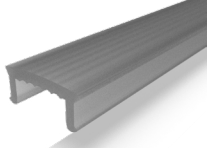

FINISH	LENS	TRANSMISSION	END CAP						
Silver 	Clear  CH-LNS-723-CL-2M	<table border="1"> <tr> <td>CL</td> <td>99%</td> </tr> <tr> <td>FR</td> <td>75%</td> </tr> <tr> <td>WH</td> <td>35%</td> </tr> </table>	CL	99%	FR	75%	WH	35%	Silver  CH-EC-723-S
CL	99%								
FR	75%								
WH	35%								
Black 	Frosted  CH-LNS-723-FR-2M		Black  CH-EC-723-BK						
	White  CH-LNS-723-WH-2M								

Kelvix reserves the right to update the product specifications at any time. To maintain warranty, field modifications must follow approved Kelvix installation instruction.

Fixture Type _____

Project Name _____

Location _____