



Complete Specification Sheet

CH-223-M

CHANNEL

CH-223-M

Extruded Aluminum Mounting Channel

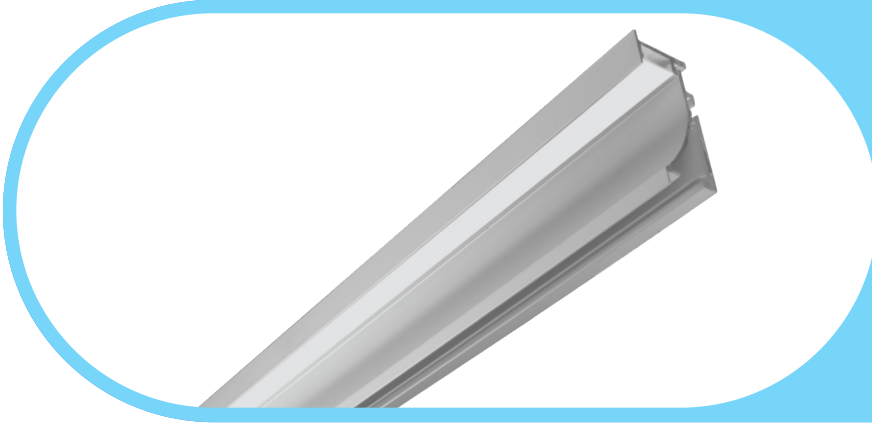

Specifications

Category	Rigid Channel
Series	Recessed / Wall Mounted
Family	CH-223-M
Width	1.00in (25.4mm)
Internal Width	0.56in (13.9mm)
Height	2.75in (70.0mm)
Material	Aluminum

Features

- Available in 2 Meter Sections
- Extruded Aluminum Construction
- Anodized Matte Finish
- Consult Factory for Custom Lengths & Finishes

Dimensions

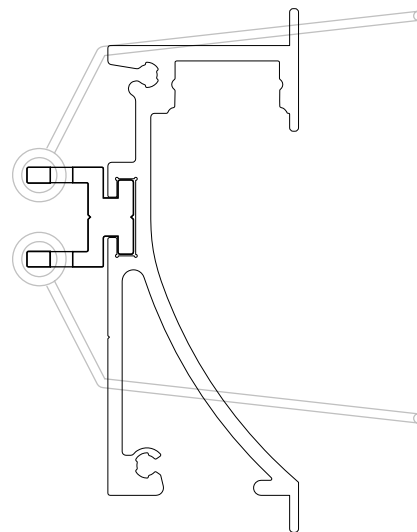
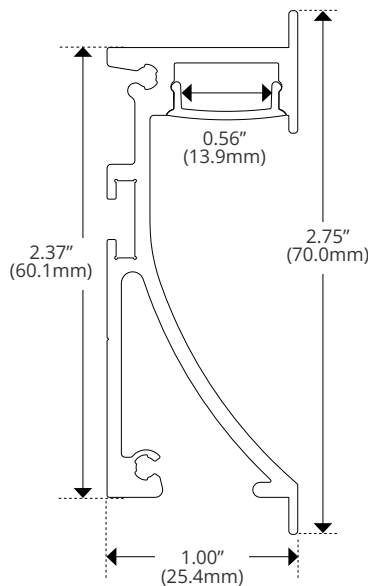

Kelvix reserves the right to update the product specifications at any time. To maintain warranty, field modifications must follow approved Kelvix installation instruction.

Fixture Type _____

Project Name _____

Location _____



Product Code Builder

CH-223-M

Product Code Builder

Example: CH-223-M-2-WH-CP-EC

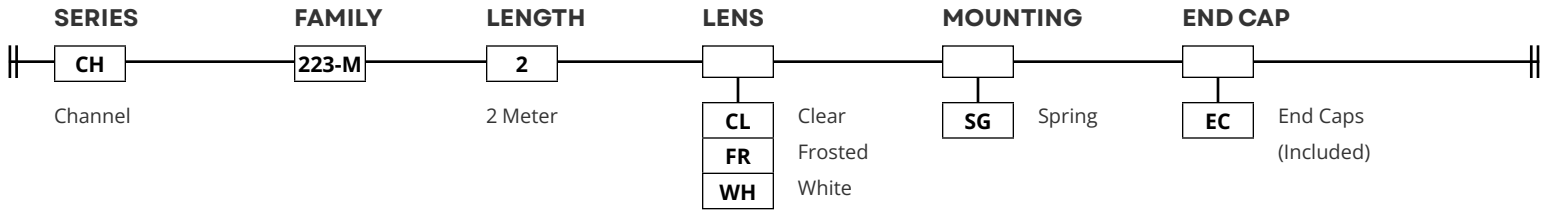

LENS

Clear



CH-LNS-M-CL-2M

TRANSMISSION

CL	99%
FR	93%
WH	75%

MOUNTING

Spring

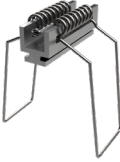

CH-CLP-223-SPR

END CAP

End Cap



CH-223-PAK-M

Frosted



CH-LNS-M-FR-2M

White



CH-LNS-M-WH-2M

Kelvix reserves the right to update the product specifications at any time. To maintain warranty, field modifications must follow approved Kelvix installation instruction.

Fixture Type _____

Project Name _____

Location _____