



Complete Specification Sheet

CH-219-N

CH-219-N

Extruded Aluminum Mounting Channel



Specifications

Category	Rigid Channel
Series	Wall Mounted
Family	CH-219-N
Width	1.70in (42.0mm)
Internal Width	1.20in (30.0mm)
Height	1.40in (35.0mm)
Material	Aluminum

Features

- Available in 2 Meter Sections
- Extruded Aluminum Construction
- Anodized Matte Finish
- Consult Factory for Custom Lengths & Finishes
- Available with continuous solid white Lens

Dimensions

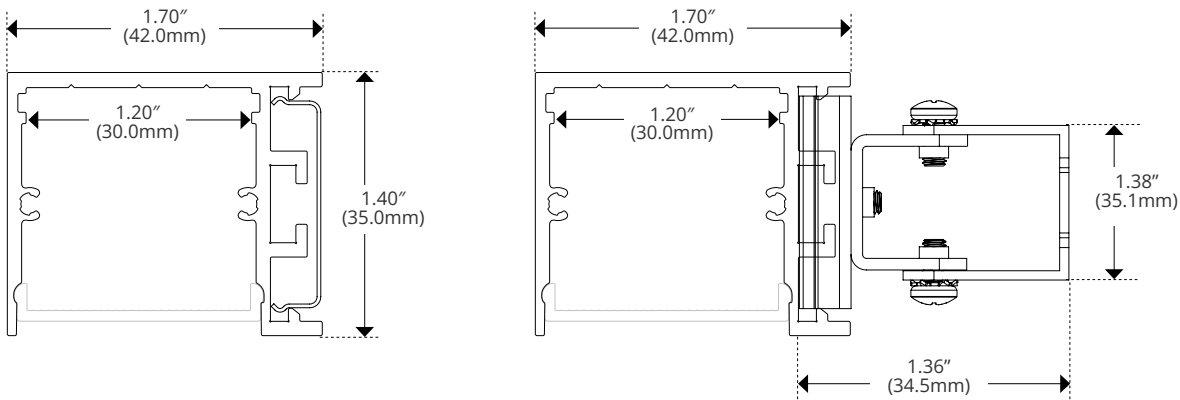

Kelvix reserves the right to update the product specifications at any time. To maintain warranty, field modifications must follow approved Kelvix installation instruction.

Fixture Type _____

Project Name _____

Location _____











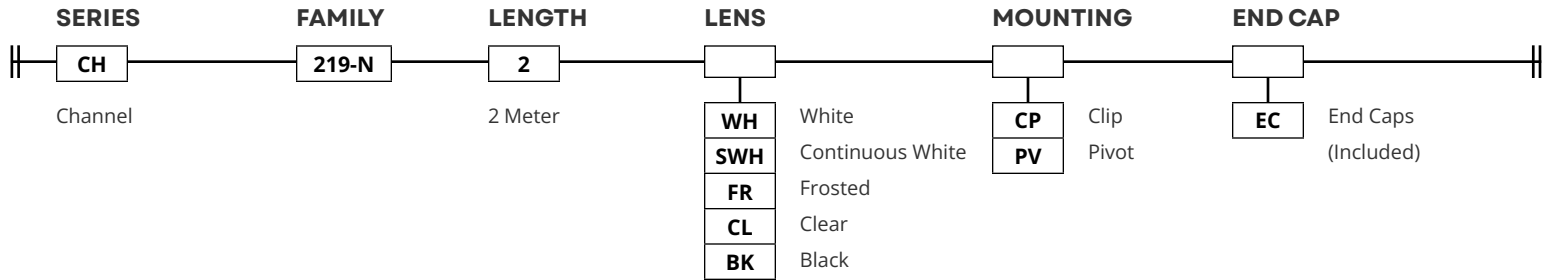

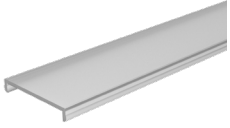
Complete Specification Sheet

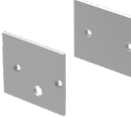
CH-219-N

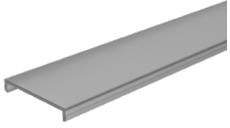
Product Code Builder

Example: CH-219-N-2-WH-CP-EC

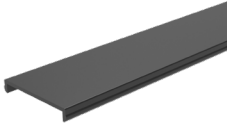

LENS	TRANSMISSION	MOUNTING	END CAP	ACCESSORIES SOLD SEPARATELY										
White / Continuous  CH-LNS-N-WH-2M	<table border="1"> <tr><td>WH</td><td>55%</td></tr> <tr><td>SWH</td><td>55%</td></tr> <tr><td>FR</td><td>88%</td></tr> <tr><td>CL</td><td>92%</td></tr> <tr><td>BK</td><td>18%</td></tr> </table>	WH	55%	SWH	55%	FR	88%	CL	92%	BK	18%	Clip  CH-219-PAK	End Cap  CH-EC-219	90° Horizontal Connector  CH-CON-01-90H
WH	55%													
SWH	55%													
FR	88%													
CL	92%													
BK	18%													
Frosted  CH-LNS-N-FR-2M		Pivot  CH-218-R1-PAK-PV		90° Vertical Connector  CH-CON-01-90V										
Clear  CH-LNS-N-CL-2M				120° Horizontal Connector  CH-CON-01-120H										
Black  CH-LNS-N-BK-2M				135° Horizontal Connector  CH-CON-01-135H										

Kelvix reserves the right to update the product specifications at any time. To maintain warranty, field modifications must follow approved Kelvix installation instruction.

Fixture Type _____

Project Name _____

Location _____