



# Complete Specification Sheet

## CH-217-N

# CH-217-N

Extruded Aluminum Mounting Channel



### Specifications

<b>Category</b>	Rigid Channel
<b>Series</b>	Recessed
<b>Family</b>	CH-217-N
<b>Width</b>	1.93in (49.0mm)
<b>Internal Width</b>	1.25" (31.0mm)
<b>Height</b>	1.50in (37.5mm)
<b>Material</b>	Aluminum

### Features

- Available in 2 Meter Sections
- Extruded Aluminum Construction
- Anodized Matte Finish
- Consult Factory for Custom Lengths & Finishes
- Available with continuous solid white Lens

### Dimensions

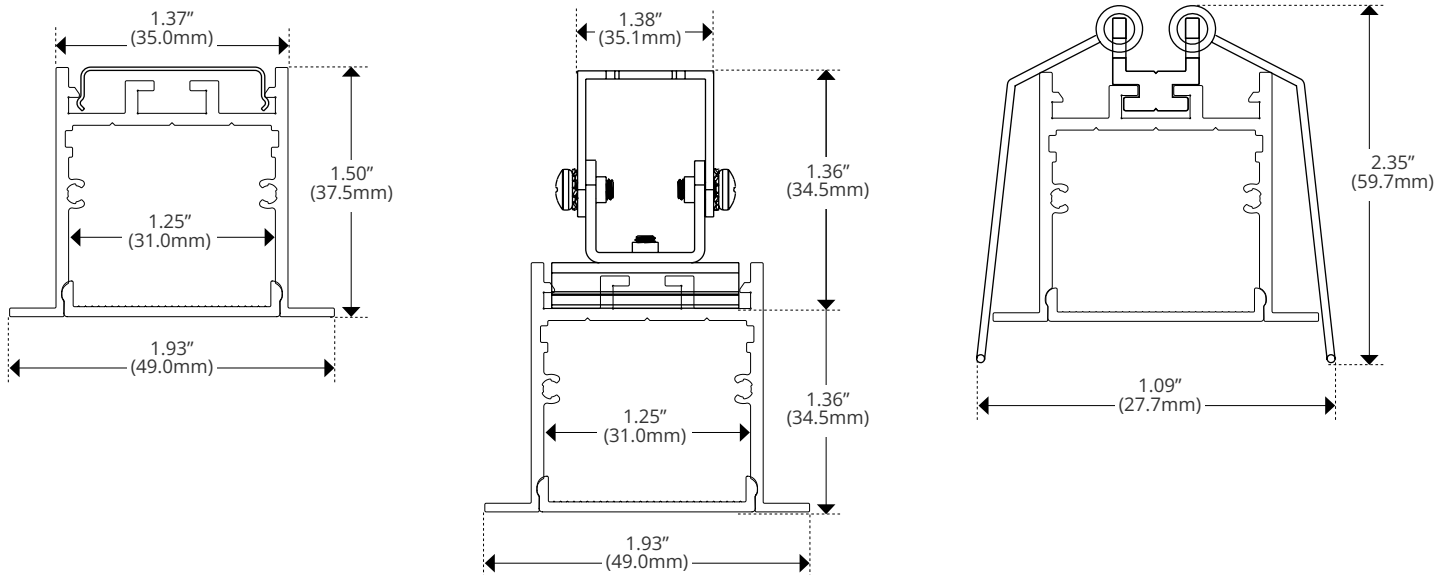

Kelvix reserves the right to update the product specifications at any time. To maintain warranty, field modifications must follow approved Kelvix installation instruction.

Fixture Type \_\_\_\_\_

Project Name \_\_\_\_\_

Location \_\_\_\_\_



# Product Code Builder

## CH-217-N

### Product Code Builder

Example: CH-217-N-2-WH-CP-EC

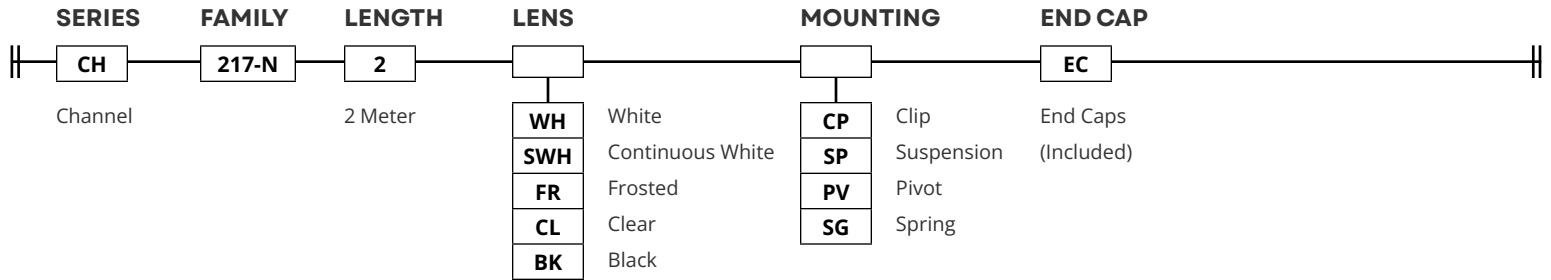

**LENS**

**White / Continuous**



CH-LNS-N-WH-2M

**TRANSMISSION**

<b>WH</b>	55%
<b>SWH</b>	55%
<b>FR</b>	88%
<b>CL</b>	92%
<b>BK</b>	18%

**MOUNTING**

**Clip**



CH-217-PAK

**END CAP**

**End Cap**

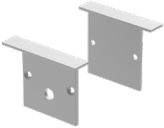

CH-EC-217

**Frosted**

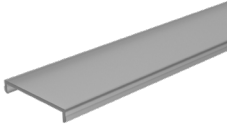

CH-LNS-N-FR-2M

**Suspension**



CH-S-228

**Clear**



CH-LNS-N-CL-2M

**Pivot**



CH-218-R1-PAK-PV

**Black**

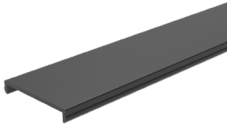

CH-LNS-N-BK-2M

**Spring**

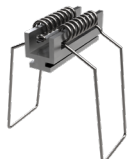

CH-CLP-217-SPRING

Kelvix reserves the right to update the product specifications at any time. To maintain warranty, field modifications must follow approved Kelvix installation instruction.

Fixture Type \_\_\_\_\_

Project Name \_\_\_\_\_

Location \_\_\_\_\_