



Complete Specification Sheet

CH-0012

Channel 0012

Extruded Aluminum Mounting Channel

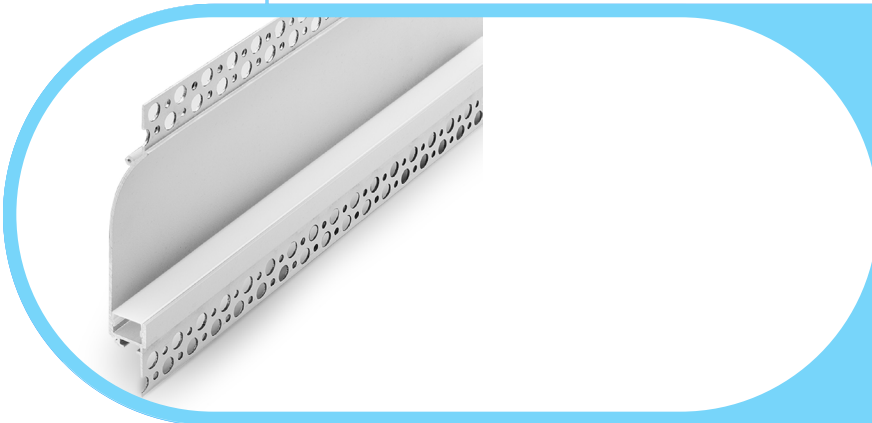

Specifications

Category	Rigid Channel
Series	Trimless / Mud-In
Family	CH-0012
Width	5.26in (133.8mm)
Internal Width	0.54in (13.7mm)
Height	0.72in (18.5mm)
Material	Aluminum

Features

- Create perfectly flush, seamless lines of light without modifying the structure behind the sheet rock.
- Available in 2 Meter Sections
- Extruded Aluminum Construction
- Anodized Matte Finish
- Straight and Angled Connectors Available to Create Long, Continuous Runs
- Drywall Mud-in Mounting for a Seamless Recessed Look
- Consult Factory for Custom Lengths and Finishes
- Available In Various Finish Colors

Dimensions

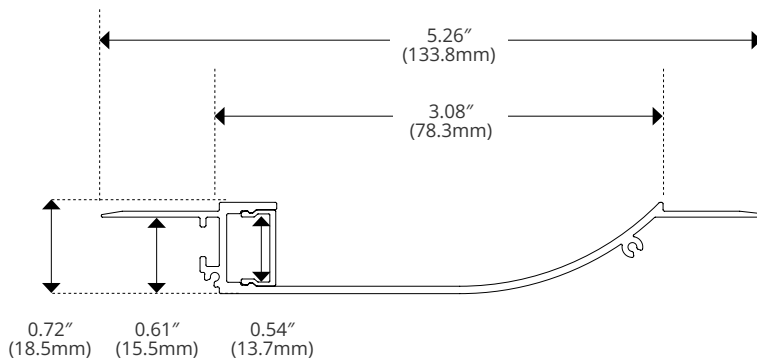

Kelvix reserves the right to update the product specifications at any time. To maintain warranty, field modifications must follow approved Kelvix installation instruction.

Fixture Type _____

Project Name _____

Location _____











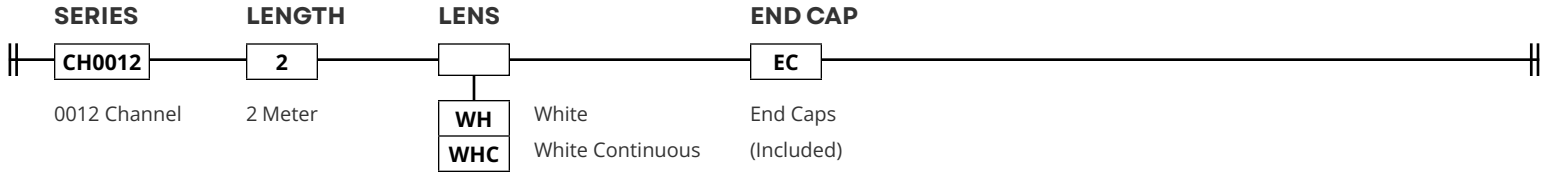

Product Code Builder

CH-0012

Product Code Builder

Example: CH012-2-WH-EC



LENS	TRANSMISSION	END CAP	ACCESSORIES SOLD SEPARATELY					
<p>White</p>  <p>CH-LNS-AD-WH-2M</p>	<table border="1"> <tr> <td>WH</td> <td>70%</td> </tr> <tr> <td>WHC</td> <td>70%</td> </tr> </table>	WH	70%	WHC	70%	<p>End Cap</p>  <p>CH-ECR-0012</p>	<p>90° Horizontal Connector</p>  <p>CH-CON-01-90H</p>	<p>135° Vertical Connector</p>  <p>CH-CON-01-135V</p>
WH	70%							
WHC	70%							
<p>White Continuous</p>  <p>CH-LNS-AD-WH-CO</p>			<p>90° Vertical Connector</p>  <p>CH-CON-01-90V</p>	<p>180° Connector</p>  <p>CH-CON-01-180</p>				
<p>Disposable Cover</p>  <p>Used to protect interior LED area during Installation</p>			<p>120° Horizontal Connector</p>  <p>CH-CON-01-120H</p>					
			<p>135° Horizontal Connector</p>  <p>CH-CON-01-135H</p>					

Kelvix reserves the right to update the product specifications at any time. To maintain warranty, field modifications must follow approved Kelvix installation instruction.

Fixture Type _____

Project Name _____

Location _____