

FIXTURE TYPE _____

PROJECT NAME _____

LOCATION _____



CH-218-N

EXTRUDED ALUMINUM MOUNTING CHANNEL



I Features

- Available in 2 Meter Sections
- Extruded Aluminum Construction
- Anodized Matte Finish
- Consult Factory for Custom Lengths & Finishes







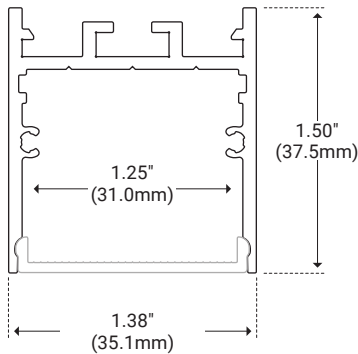

I Specifications

Series	CH-218-N
Length	78.74" (2M)
Width	1.38" (35.1mm)
Internal Width	1.25" (31.0mm)
Height	1.50" (37.5mm)

I Dimensions



I Options

	Description	Unit Number
	White Lens	WH
	Frosted Lens	FR
	Clear Lens	CL
	Suspension Cable	SP
	Mounting Clips	CP
	Pivot Clips	PV
	End Cap With Hole	EC
	End Cap Without Hole	EC

I Product Code Builder

Series	Length	Lens	Mounting	End Cap
CH-218-N	2			EC
CH-218-N – CH-218-N	2 – 2 Meters	WH – White FR – Frosted CL – Clear	CP – Mounting Clip SP – Suspension PV – Pivot Clip	EC – End Caps (included)

Example: CH-218-N-2-WH-CP-EC



I Accessories (Sold Separately)

Aluminum Cover

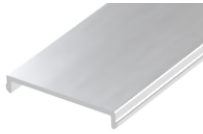

Unit Number	CH-LNS-N-MT-2M
Length	78.74" (2000mm)
Width	1.32" (33.5mm)
Height	0.18" (5.3mm)
Height w/Product	1.50" (37.5mm)

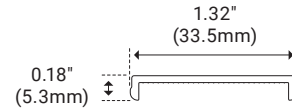

90° Horizontal Corner Connector



Unit Number	CH-CON-01-90H
Length	1.97" (50.1mm)
Width	0.37" (9.5mm)
Height	0.09" (2.5mm)

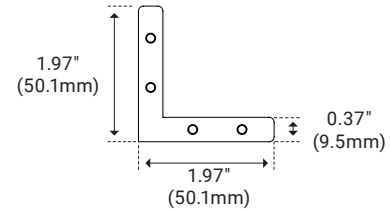

90° Vertical Corner Connector



Unit Number	CH-CON-01-90V
Length	1.65" (42.0mm)
Width	0.37" (9.5mm)
Height	0.09" (2.5mm)

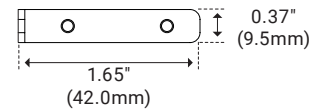

110° Horizontal Corner Connector



Unit Number	CH-CON-01-110H
Length	1.92" (49.0mm)
Width	0.37" (9.5mm)
Height	0.09" (2.5mm)

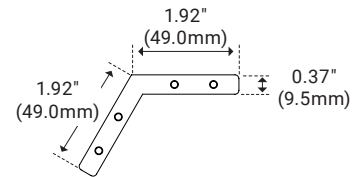

180° Straight Coupler



Unit Number	CH-CON-21X-180
Length	4.72" (120.0mm)
Width	0.39" (9.9mm)
Height	0.17" (4.39mm)

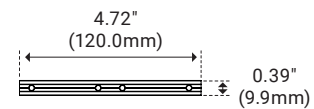

Note: 2 Per 2M Section Provided