

FIXTURE TYPE _____

PROJECT NAME _____

LOCATION _____



CH-206-M

EXTRUDED ALUMINUM MOUNTING CHANNEL



I Features

- Available in 2 Meter Sections
- Extruded Aluminum Construction
- Anodized Matte Finish
- Consult Factory for Custom Lengths & Finishes





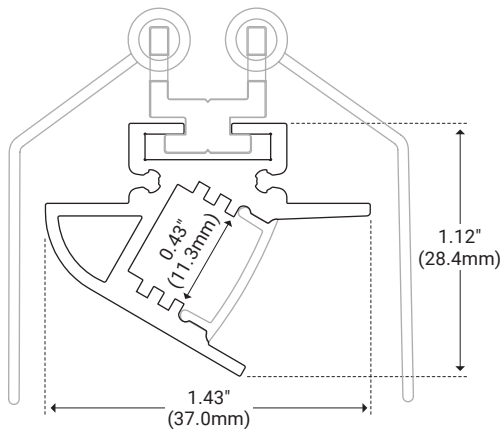

I Specifications

Series	CH-206-M
Length	78.74" (2M)
Width	1.43" (37.0mm)
Internal Width	0.43" (11.3mm)
Height	1.12" (28.4mm)

I Dimensions



I Options

	Description	Unit Number
	White Lens	WH
	Frosted Lens	FR
	Clear Lens	CL
	Spring Clips	SG
	End Cap With Hole	EC
	End Cap Without Hole	EC

I Product Code Builder

Series	Length	Lens	Mounting	End Cap
CH-206-M	2		SG	EC
CH-206-M – CH-206-M	2 – 2 Meters	WH – White FR – Frosted CL – Clear	SG – Spring Clip	EC – End Caps (included)

Example: CH-206-M-2-WH-SG-EC