

FIXTURE TYPE _____

PROJECT NAME _____

LOCATION _____



AC Zolo™ 7

LINE VOLTAGE WASHER/GRAZER



Description

The AC Zolo 7 is the first line voltage option in our flagship grazing series. Available with a variety of optics, accessories, and color temperature options without the need for remote drivers.

Dimensions

Length	Variable (see below)
Width	1.97" (50mm)
Height	2.70" (69.3mm)

Features

- High Purity Tempered Glass
- Extruded Aluminum Alloy Housing
- Available in Titanium Gray, Black, or White Finish*
- Daisy Chain Multiple Fixtures
- IP66 Outdoor Rated
- Louver Options Available

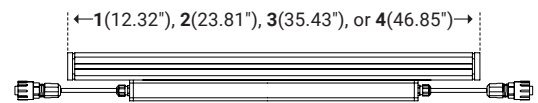

Specifications

Input Voltage	120-277VAC
Color Options	2700K, 3000K, 3500K, 4000K
Watts per Foot	9W/ft
Lumen per Watt	100 lm/W
Lumen per Foot	900 lm/ft
Beam Spread	10°x55°, 20°x40°, 13°, 20°, 25°, 35°, 50°
Max Run Length	75ft at 120V AC 125ft at 277V AC
CRI	80*
Dimming Options	0-10V, DMX, DALI, ON/OFF
Operating Temp. Range	-40°F (-40°C) to 140°F (60°C)
Storage Temp.	-40°F (-40°C) to 185°F (85°C)

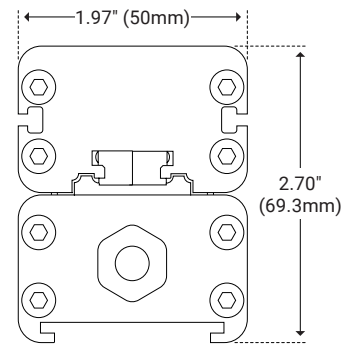

* Customizable—Consult Factory



I Ordering Code Builder

Item	Length	Power	Fixture Type	Dimming
Z7AC		9	W	
Z7AC – AC Zolo 7	1 – 12.32" (313mm) 2 – 23.81" (605mm) 3 – 35.43" (900mm) 4 – 46.85" (1190mm)	9 – 9W/ft	W – White Light	Z – 0–10V X – DMX D – DALI F – ON/OFF
Color*	Beam Angle	Mounting	Finish*	Option
27 – 2700K 30 – 3000K 35 – 3500K 40 – 4000K	1055 – 10°x55° 2040 – 20°x40° 13 – 13° 20 – 20° 25 – 25° 35 – 35° 50 – 50°	S2 – 2" Stand Off S3 – 3" Stand Off GS – Ground Stake L3 – L Bracket	TG – Titanium Gray BK – Black WH – White	NA – None LV – Louver ALV – Asymmetric Louver

Example: Z7AC-1-9-W-Z-27-1055-S2-TG-LV

* Customizable—Consult Factory

I Mounting

2" Stand Off



Unit Number	Z-07-S2
Ordering Code	S2
Foot Length	1.18" (30mm)
Foot Width	2.36" (60mm)
Stand Off Height	1.83" (46.4mm)

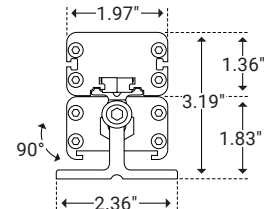

3" Stand Off



Unit Number	Z-07-S3
Ordering Code	S3
Foot Length	1.18" (30mm)
Foot Width	2.36" (60mm)
Stand Off Height	2.59" (66mm)

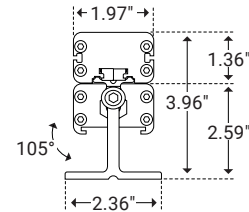

Ground Stake



Unit Number	Z-07-GS
Ordering Code	GS
Stake Length	8.23" (209mm)
Stake Width	1.96" (50mm)

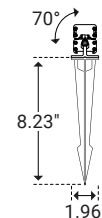

L Bracket



Unit Number	Z-07-L3
Ordering Code	L3
Foot Length	1.18" (30mm)
Foot Width	2.36" (59.9mm)
Stand Off Height	2.64" (66.9mm)

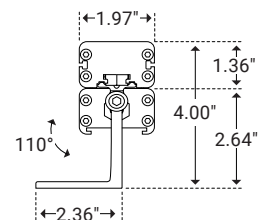



I Glare Options

Louver



Unit Number	Z-07-LV
Ordering Code	LV
Louver Width	2.10" (53.3mm)
Louver Height	0.78" (20mm)
Overall Height	1.29" (33mm)

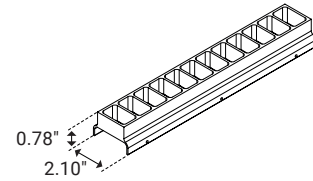

Asymmetric Louver



Unit Number	Z-07-ALV
Ordering Code	ALV
Louver Width	2.10" (53.3mm)
Louver Height	0.78" (20mm)
Overall Height	1.29" (33mm)

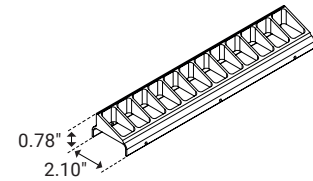

I Power & Connectors

Power Lead



Unit Number	Length
Z-7AC-FML-6	6ft
Z-7AC-FML-20	20ft
Z-7AC-FML-50	50ft

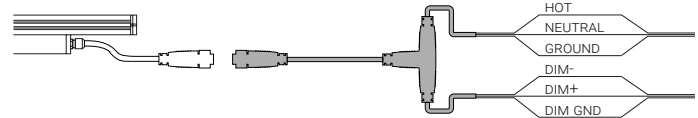

Connector



Unit Number	Length
Z-7AC-FMC-1	1ft
Z-7AC-FMC-2	2ft
Z-7AC-FMC-6	6ft



T-Connector



Unit Number
Z-7AC-TCONNECTOR

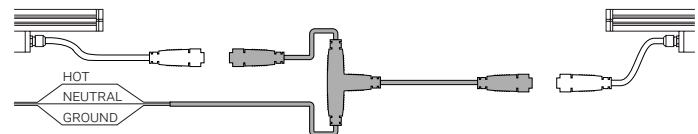

End Cap



Unit Number
Z-7AC-END-DMX
Z-7AC-END

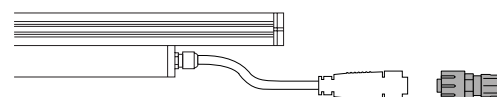



Wiring Options

0-10V

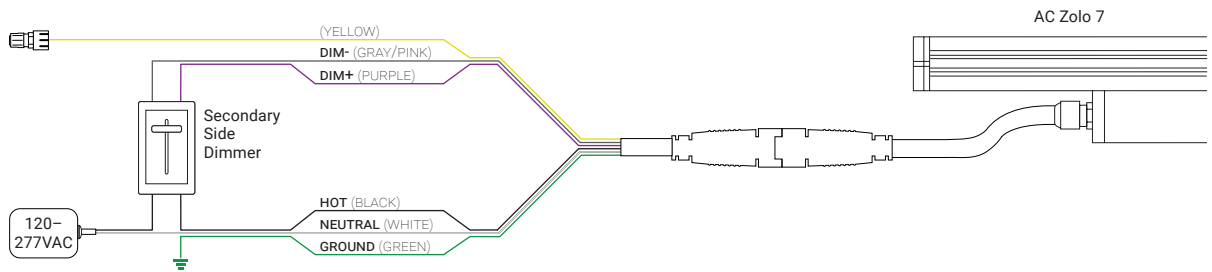

DMX

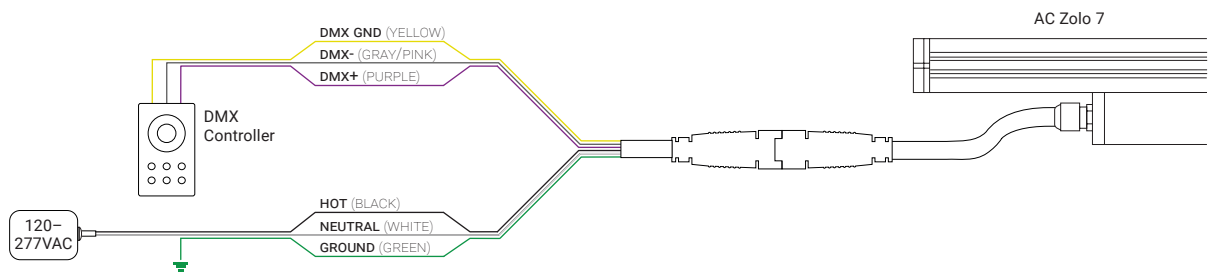

DALI

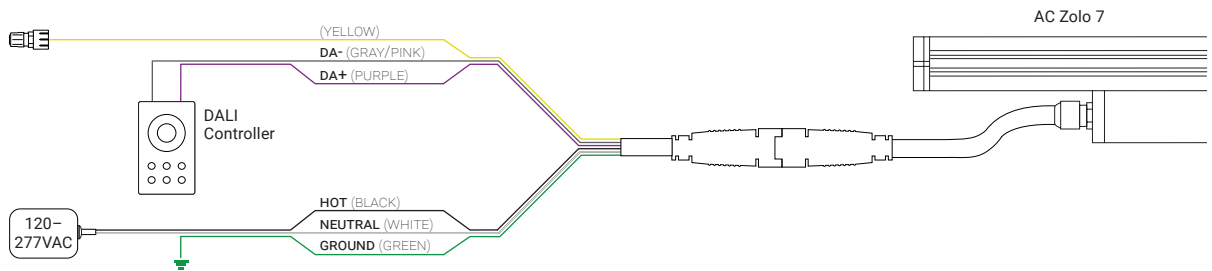

ON/OFF

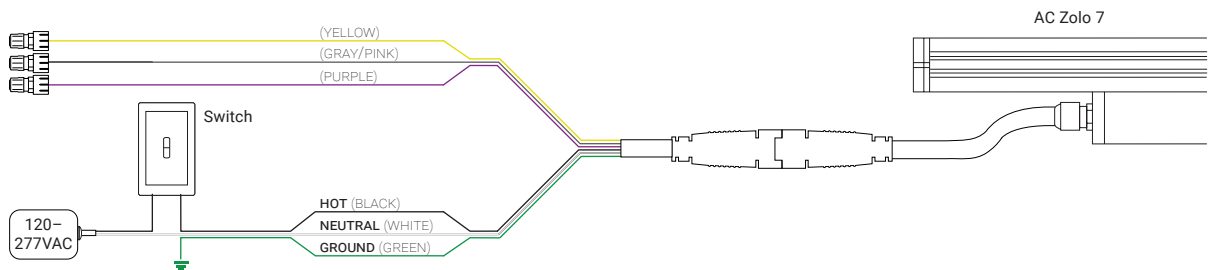



I Daisy Chain

Multiple Fixtures

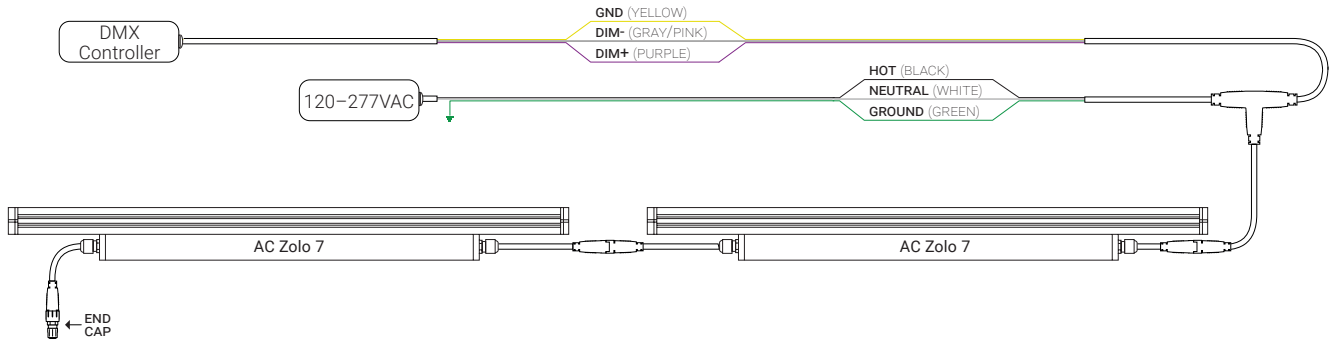

Multiple Power Sources

