



Mud-In

Installation Instructions

⚠ SAFETY PRECAUTIONS

The mounting means provided with this luminaire has not been evaluated for reliability. If installed where failure of the mounting could cause injury to persons or damage to property below, supplemental means of securement should be considered.

Products should be installed and serviced by a qualified, licensed electrician in accordance with applicable local and national electrical safety codes.

Never install within 10 ft or less from the nearest edge of a pool, spa, fountain, or similar location.

Never use currents or voltages that are not compatible.

Never modify or take apart Kelvix components beyond instructions or the warranty will be void.

Connect power feed to appropriate power source or controls.

Ensure all electrical connections are insulated and secure before applying power.

Remove from power source immediately if any damage is found in the LED strip or cabling.

- 1 | Create recessed opening in mounting surface.

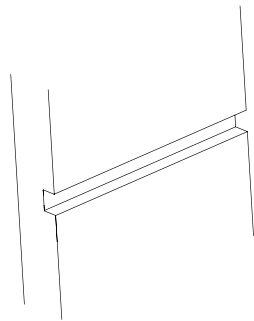

- 2 | Insert disposable cover into channel, measure, and cut to length.

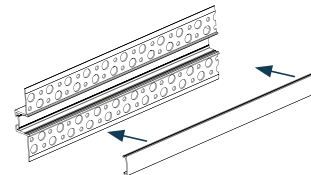

- 3 | Remove disposable cover from channel.

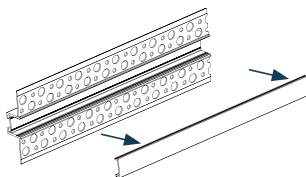

- 4 | If using more than 2 meters attach connectors. (Optional)

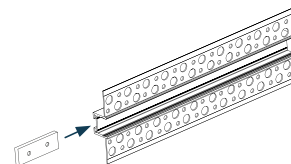

- 5 | Attach end caps and screw channel through pre-drilled holes directly into recessed mounting surface.

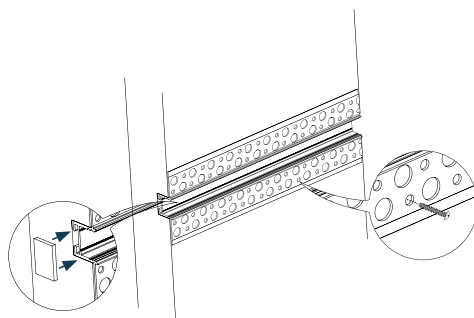

- 6 | Install LED strip into channel and route wire back to remote power supply location.

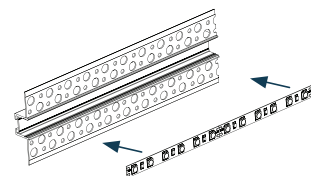



Mud-In

Installation Instructions

7 | Attach disposable cover to channel.

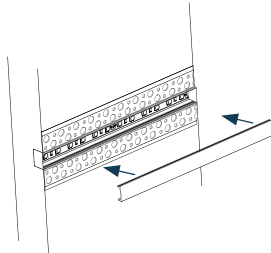

8 | Tape and mud over mounting surface, bring mud flush to edge of disposable cover.

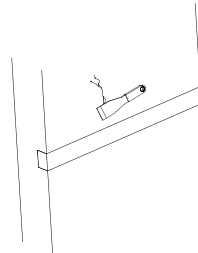

9 | Sand mudded surface to remove any raised points from previous step.

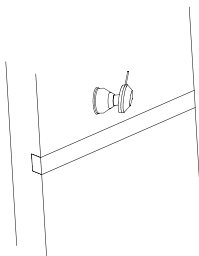

10 | Paint surface.

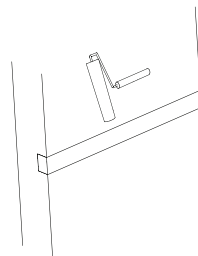

11 | Remove disposable cover and wipe down LED strip to remove dust.

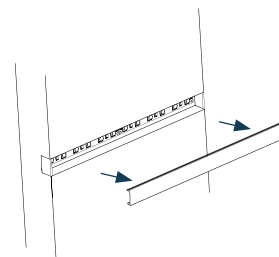

12 | Measure and cut lens to length and attach to channel.

