



Orex™

Plastic Mounting Base Installation Instructions

⚠ SAFETY PRECAUTIONS

VOLTAGE

Hazardous voltage present. Please verify voltage prior to connecting and install per state and local codes.



PRODUCT MODIFICATIONS

Product is NOT to be modified in the field. Modifications will void ETL listing and warranty.

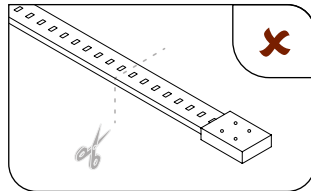

DAMAGE

Remove from power source immediately if any damage is found in the LED strip or cabling.

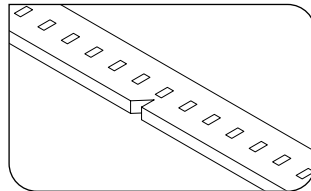

TWISTING

Do not twist or bend product excessively. Do not hit or pull the product with excessive force.

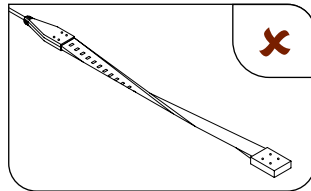

CABLE HANDLING

The first 2.36" (60mm) of the cable should maintain its natural state before any bending accrues.

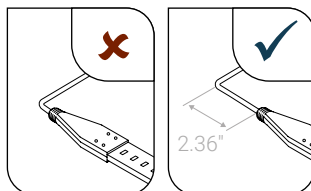

SECURE CONNECTIONS

Ensure all electrical connections are insulated and secure before applying power.

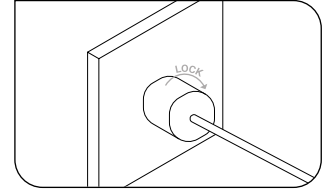

PROPER CONNECTIONS

Connect power feed to appropriate power source or controls.

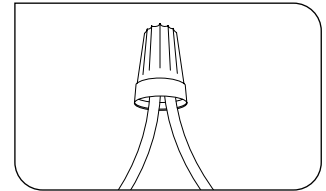

BENDING LIMITS

Do not bend product smaller than bending diameter: 11.81" (300mm).

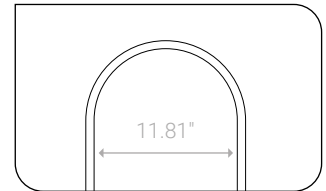

POWER TESTING

Do not power up while coiled for over 30 minutes. This may lead to overheating and damage.

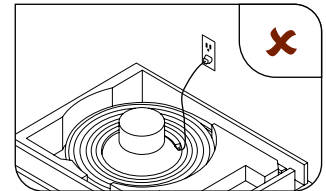

KELVIX ACCESSORIES

The use of third-party accessories must be pre-approved by Kelvix. Failure to do so will void manufacturer warranty.





Orex™

Plastic Mounting Base Installation Instructions

- 1 | Measure and cut base to length as needed.

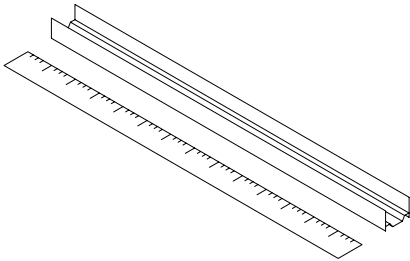

- 2 | Drill mounting holes through base.

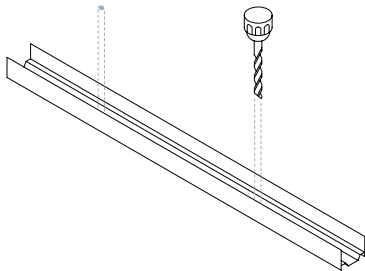

- 3 | Screw base through pre-drilled holes directly into mounting surface.

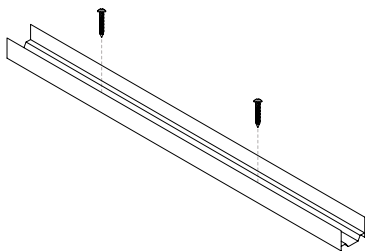

PROFILE ALIGNMENT
When using multiple channels the channel junctions should be aligned and the gap between should be at least 0.19" (5mm).

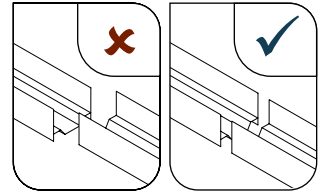

EXPANSION JOINTS
Do not connect two channels at an expansion joint. Cross the expansion joint near the middle of the channel.

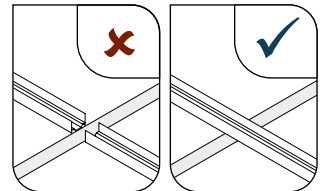

PROFILE SECURING
Ensure screws are driven vertically and flush to bottom edge to avoid damaging the outer jacket during installation.

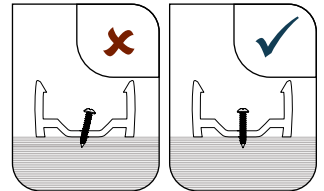



Orex™

Plastic Mounting Base Installation Instructions

- 4 | Remove 3M backing then apply LED strip into the base (power feed and end cap will extend past the end of the base).

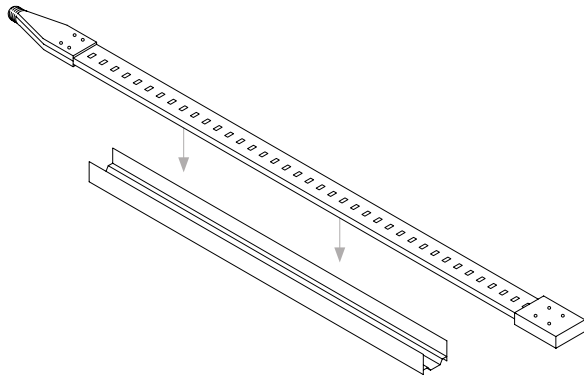

- 5 | Hardwire in standard J-Box. Connect to AC Power after verifying all electrical connections.

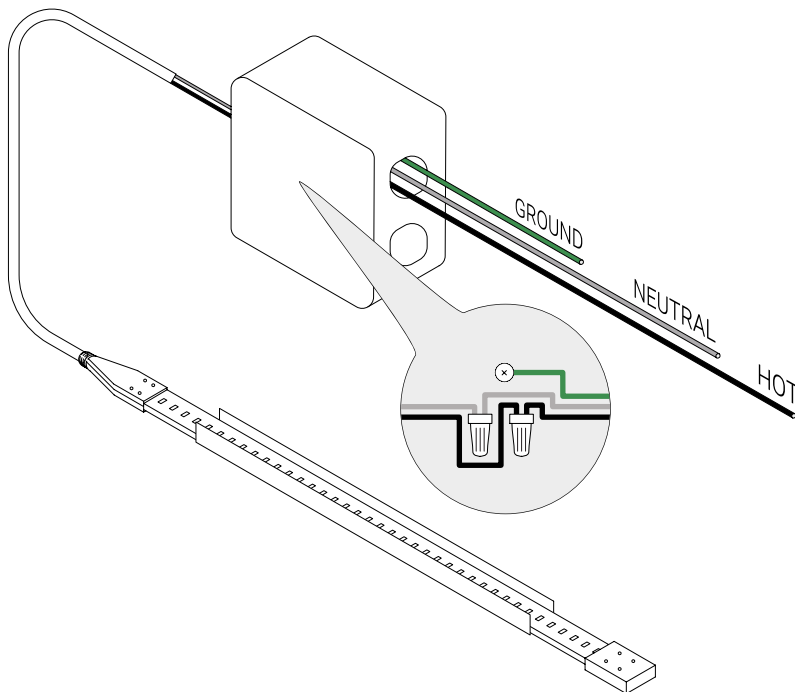

DIMMING

For 0-10V wiring, please refer to the corresponding LCX spec sheet for details or reach out to our team.

