



Easy-Spec™ Continuous Lens Suspended

Installation Instructions

⚠ SAFETY PRECAUTIONS

The mounting means provided with this luminaire has not been evaluated for reliability. If installed where failure of the mounting could cause injury to persons or damage to property below, supplemental means of securement should be considered.

Products should be installed and serviced by a qualified, licensed electrician in accordance with applicable local and national electrical safety codes.

Never install within 10 ft or less from the nearest edge of a pool, spa, fountain, or similar location.

Never use currents or voltages that are not compatible.

Never modify or take apart Kelvix components beyond instructions or the warranty will be void.

Connect power feed to appropriate power source or controls.

Ensure all electrical connections are insulated and secure before applying power.

Remove from power source immediately if any damage is found in the LED strip or cabling.

- 1 | Measure and cut channel to desired length.

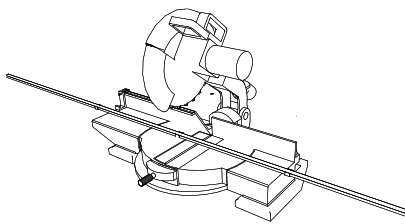

- 2 | Unscrew t-screws from channel couplers and feed through slot on back of channel.

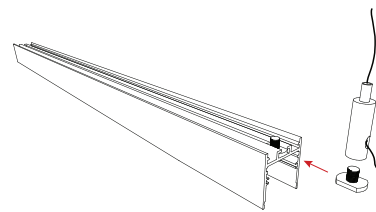

- 3 | Couple all fixtures together within a run.

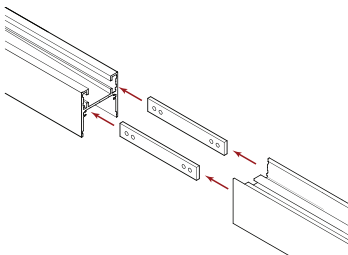

- 4 | Tighten coupler screws to join fixtures.

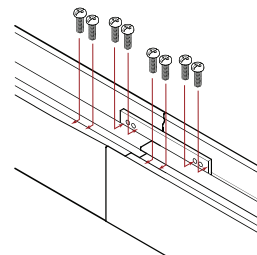

- 5 | Drill hole for power feed at one end of the channel run.

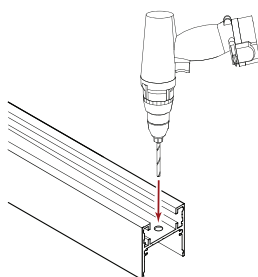

- 6 | Clean channel to remove any dirt, debris, or moisture.

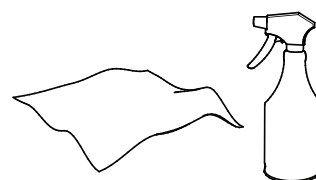



Easy-Spec™ Continuous Lens Suspended

Installation Instructions

- 7 | Orient LED strip with power feed end toward power source.

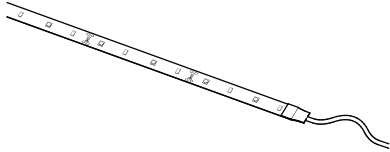

- 8 | Peel off 3M™ adhesive backing and adhere LED strip to the inside bottom of the channel.

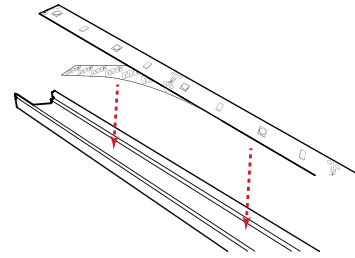

- 9 | Gently go back and press down along entire strip to remove any air pockets and secure into position.

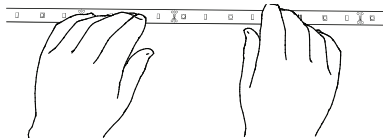

- 10 | Slide grommet over power feed and run both out to channel exterior through hole drilled in step 5.

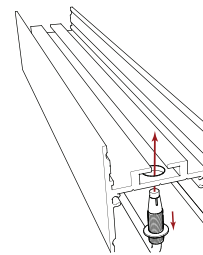

- 11 | Thread cap onto bottom half of power feed grommet. Tighten to hold power feed in place.

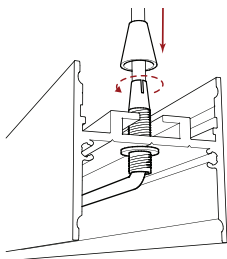

- 12 | Attach end caps.

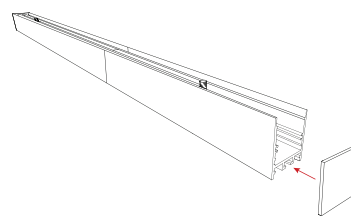



Easy-Spec™ Continuous Lens Suspended

Installation Instructions

- 13 | Measure ceiling and channel to determine suspension points.

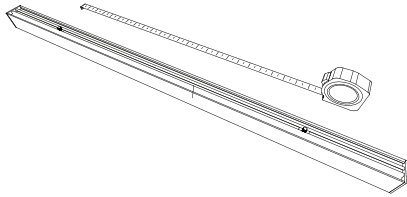

- 14 | Thread channel couplers back onto t-screws at desired suspension points.

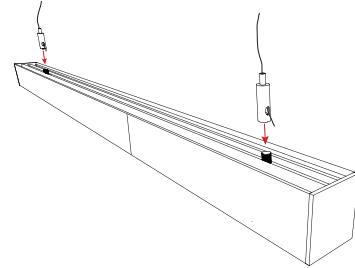

- 15 | Remove t-screws from ceiling couplers and mount to ceiling with appropriate hardware.

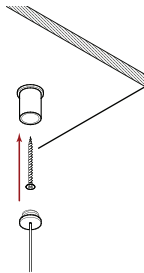

- 16 | Thread t-screws back into ceiling couplers to suspend channel.

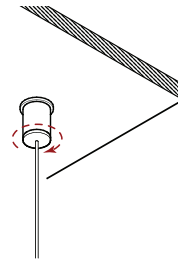

- 17 | Adjust height of channel by compressing end of channel coupler and adjusting cable length.

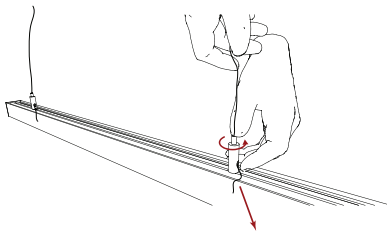

- 18 | If desired, clip excess suspension cable with wire cutters.

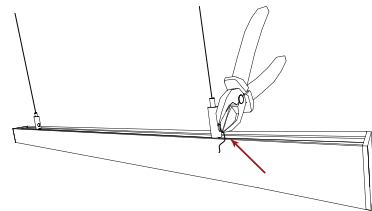



Easy-Spec™ Continuous Lens Suspended

Installation Instructions

- 19 | Apply light-blocking tape to the inside of all joined fixture seams to eliminate light gaps.

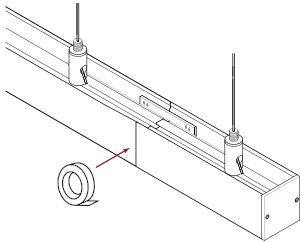

- 20 | Measure total channel run.

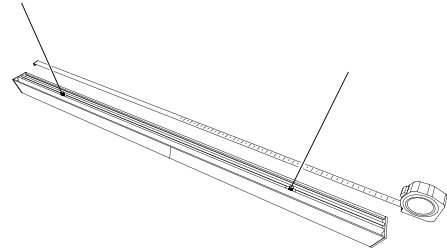

- 21 | Cut lens to length measured in step 17.

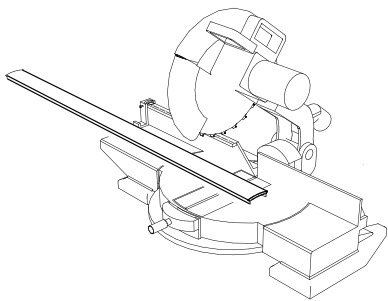

- 22 | Snap lens into channel.

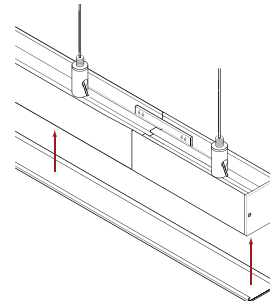

- 23 | Install power supply (see page 5-6 for detailed installation steps).

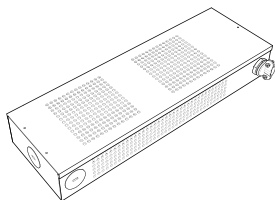

- 24 | Turn on fixture and enjoy!

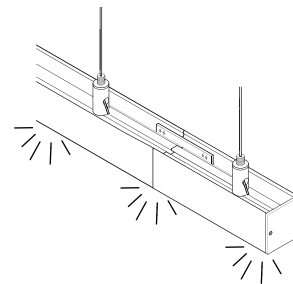



ULV Power Supply

Installation Instructions

1 | Remove wiring cover.

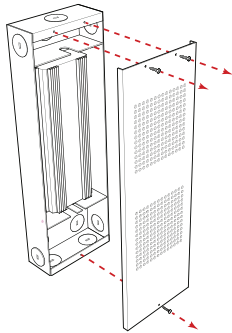

2 | Secure power supply to mounting surface.

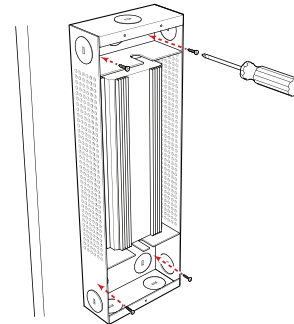

3 | Install romex connectors in 1/2 KOs where necessary.

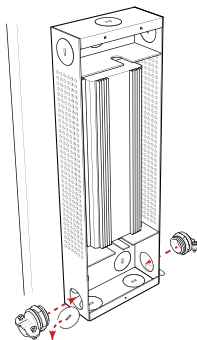

4 | Refer to ULV96 Wiring Options (next page) to configure setup for the appropriate application.



5 | Replace wiring cover.

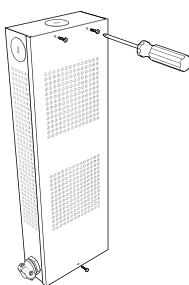



ULV Wiring Options

Installation Instructions

PRIMARY SIDE DIMMING (120V ONLY)

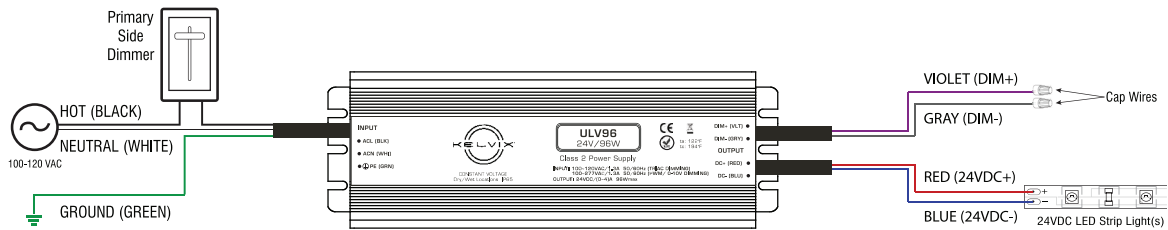

PRIMARY SIDE SWITCHING (120-277V)

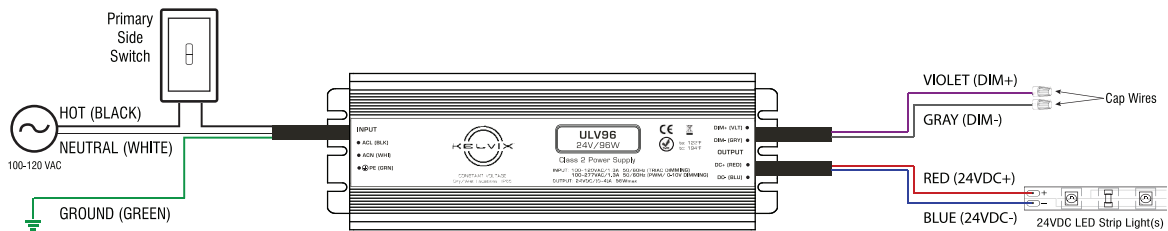

SECONDARY SIDE DIMMING (0-10V)

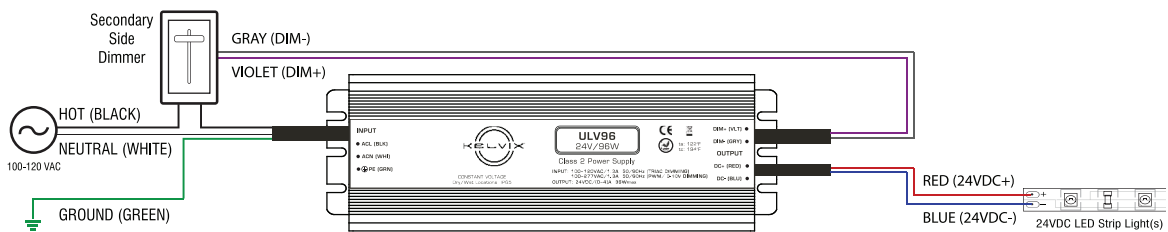

SECONDARY SIDE DIMMING (DMX)

