



VINE™

VN-SERIES | FLEXIBLE LIGHTING SYSTEM

Fixture Type: _____

Project: _____

Location: _____

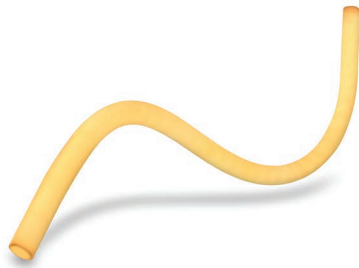

BEND RADIUS

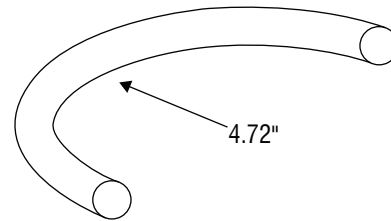

MODEL:	VN24K	VN27K	VN30K	VN35K	VN40K
Kelvin	2400K	2700K	3000K	3500K	4000K
Lumens	230 lm/ft	268 lm/ft	275 lm/ft	281 lm/ft	290 lm/ft

PRODUCT FEATURES

- 360° Continuous Light Source
- Universal Dimming
- 36,000 Hour Life
- IP65 Rated for Outdoor Use
- Factory-Installed Power Feed
- Injection-Molded Flush End Caps
- For Use with 24V Power Supplies

SPECIFICATIONS

Series	VN—Vine™
Input Voltage	24V DC
Watts per Foot	4.39 W/FT
Max Run Length	Unlimited, Power Feed Every 16.4ft
Beam Angle	360°
Dimensions	1" (25mm)
Min Bend Radius	4.72" (120mm)
CRI	90+
Dimming Options	PWM, Triac, 0-10V, DMX, Hi-lume
Temp Range	-22°F (-30°C) to 131°F (55°C)

ORDERING INFORMATION

Example: **VN-25-48-30K-E-72**

Series	Diameter	Length (Unlimited)	Color	Feed Point	Feed Length
VN	25				
VN - Vine	25 - 1 Inch (25mm)	Inches	24K - 2400K 27K - 2700K 30K - 3000K 35K - 3500K 40K - 4000K	E - End Feed SF - Side Feed	72 - 72 Inch (Standard) 192 - 192 Inch

Conforms to ANSI/UL Standard 2108
Certified to CAN/CSA Standard C22.2 No. 250.0





VINE™ MOUNTING AND ACCESSORIES

VISIBLE MOUNTING CLIP



SPECIFICATIONS

Model	VN-25-CP
Material	Clear Polycarbonate
Length	0.984" (25mm)
Width	2.032" (51.6mm)
Height	1.063" (27mm)
Internal Width	1" (25.4mm)

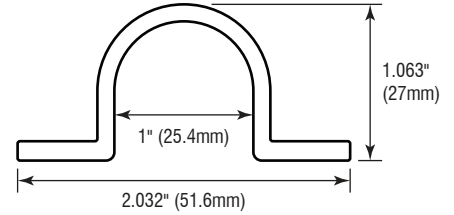

Surface Mounts Straight or Curved Runs



OR

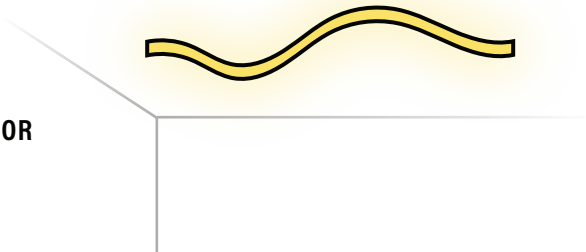

CONCEALED MOUNTING CLIP



SPECIFICATIONS

Model	VN-25-CCP
Material	Clear Polycarbonate
Length	1.43" (36mm)
Width	0.75" (19mm)
Height	0.27" (7mm)
Effective Height	0.11" (3mm)

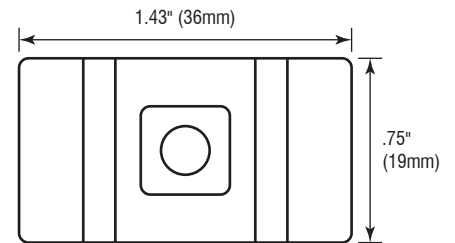

Surface Mounts Straight or Curved Runs

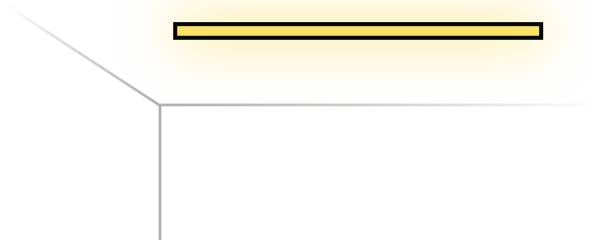

OR

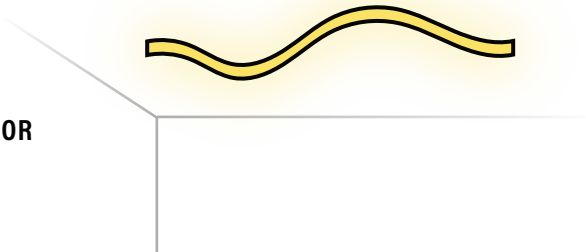



VINE™ MOUNTING AND ACCESSORIES

SPLICE



SPECIFICATIONS

Model	VN-25-CS
Material	Aluminum
Length	1.358" (34.5mm)
Diameter	1.22" (31mm)
Internal Diameter	1" (25.4mm)

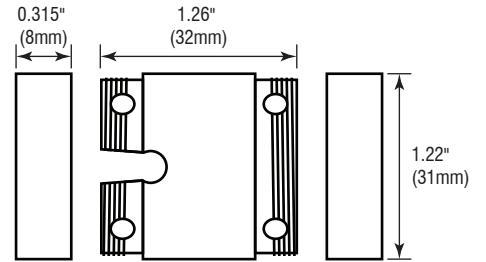

**Connects Power Feed
End to Terminal End**

For use with Side Feed option

ARCH



SPECIFICATIONS

Model	VN-25-MA-FF
Material	Aluminum
Length	1.654" (42mm)
Diameter	1.28" (32.5mm)
Internal Diameter	1" (25.4mm)

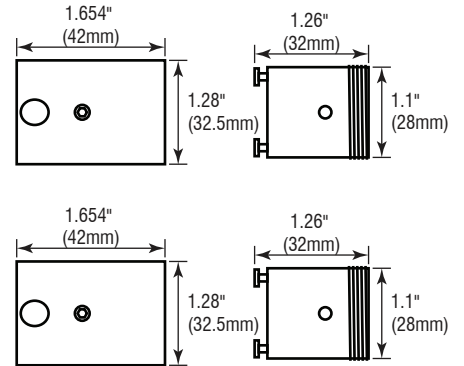

**Surface Mounts Power Feed
End and Terminal End**



VINE™ MOUNTING AND ACCESSORIES

FLUSH PENDANT

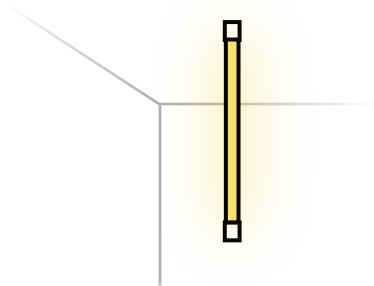

SPECIFICATIONS

Model	VN-25-FP-FF
Model w/ Sleeve*	VN-25-FP-2M
Material	Aluminum
EC Length	1.32" (33.5mm)
EC Diameter	1.24" (31.5mm)
CM Length	1.654" (42mm)
CM Diameter	1.28" (32.5mm)
Internal Diameter	1" (25.4mm)

*Polycarbonate sleeve (not pictured) is required for Vine to hang perfectly vertical.

EC—End Cap

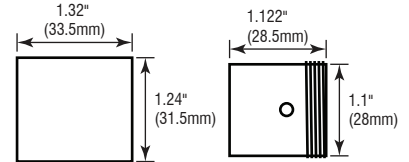

CM—Ceiling Mount

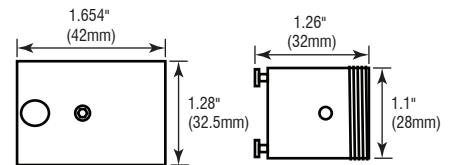

Surface Mounts Power Feed End and Caps Terminal End

SUSPENDED PENDANT

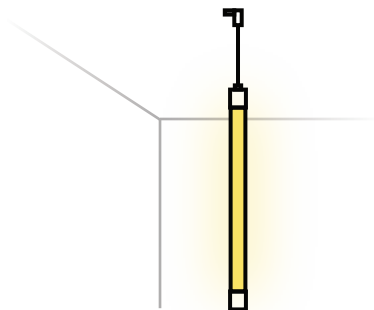

SPECIFICATIONS

Model	VN-25-SP-V-FF
Model w/ Sleeve*	VN-25-SP-V-2M
Material	Aluminum
EC Length	1.654" (42mm)
EC Diameter	1.24" (31.5mm)
SP Length	2.68" (68mm)
SP Diameter	1.24" (31.5mm)
Internal Diameter	1" (25.4mm)
Cable Length	Variable, 6ft max

*Polycarbonate sleeve (not pictured) is required for Vine to hang perfectly vertical.

EC—End Cap

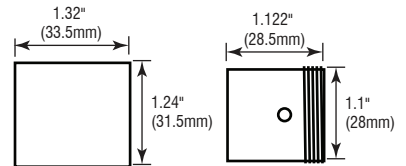

SP—Suspended Pendant

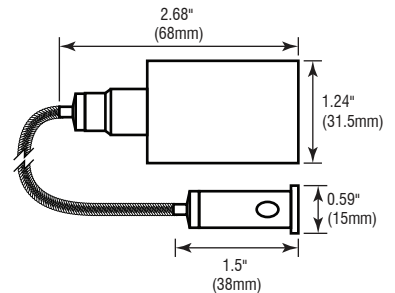

Suspends Power Feed End and Caps Terminal End



VINE™ MOUNTING AND ACCESSORIES

RING CLIP MOUNT



SPECIFICATIONS

Model	VN-25-RCP-038
Model w/ Sleeve*	VN-25-RCP-038-2M
Suspension Kit	VN-25-RCP-SP
Material	Clear Polycarbonate
Width	1.15" (29.3mm)
Diameter	1.04" (26.3mm)
Length	1.50" (38.0mm)
Height	1.29" (32.7mm)

*Polycarbonate sleeve (not pictured) is required for Vine to hang perfectly straight.

Front View

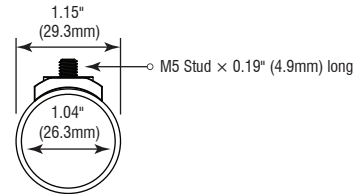

Side View

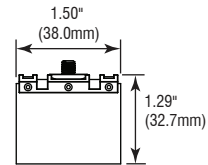

Can be used with Universal Standoff or Suspension Cable accessories



Illustration shows mounting with Side Feed option.