

FIXTURE TYPE _____

PROJECT NAME _____

LOCATION _____

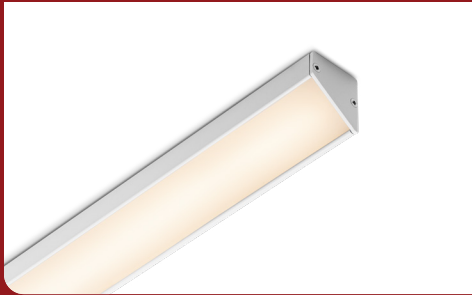

CrossBar™ Wall Washing

35° LENS FACING T-GRID FIXTURE

Store in a Temperature-Controlled Environment.



Description

Crossbar provides seamless illumination upon either axis of a drop ceiling system, requiring no modifications to an existing T-grid.

Features

- 35° Lens Facing
- Easily Mounts to Existing Grid
- Fast Installation
- Integrated Seismic Strap
- UL Listed
- 50,000 Hour Life
- Multi-Volt 24VDC Remote Driver (Sold Separately)

Specifications

Length	2ft, 4ft
Temp/Color	2700K, 3000K, 3500K, 4000K
Dimming Options	PWM, 0–10V, DMX 512, DALI, TRIAC, ELV
Finish	White
Input Voltage	24V DC
Watts per Foot	13W for 2ft, 26W for 4ft
Lumen per Foot	1100 lm for 2ft, 2200 lm for 4ft
Lumens per Watt	84 lm/W
Beam Angle	120°
Max Run Length	12ft
CRI	90+
Operating Temp.	-20°F (-29°C) to 158°F (70°C)

Product Code Builder

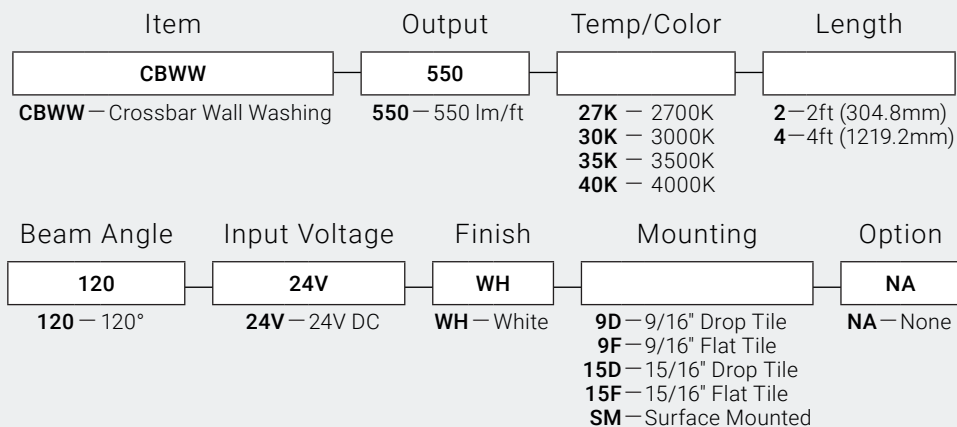

Example: CBWW-550-27K-2-120-24V-WH-9D-NA



Dimensions

Length	23.62" (600mm), 47.24" (1200mm)
Width	1.00" (25.4mm)
Height	1.10" (28.0mm)

←CBWW-2 23.62" (600mm), CBWW-4 47.24" (1200mm)→

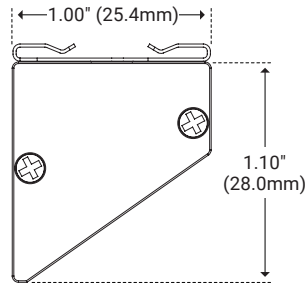
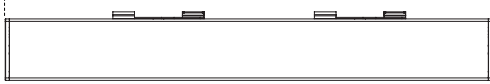

Mounting

9/16" Grid Drop Tile



Unit Number	CB-DT-9
Ordering Code	9D
Width	1.36" (34.5mm)
Length	0.92" (23.5mm)
Height	0.49" (12.6mm)

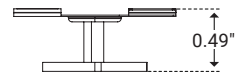
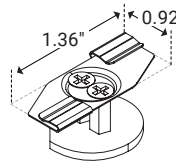

9/16" Grid Flat Tile



Unit Number	CB-FT-9
Ordering Code	9F
Width	0.85" (21.6mm)
Length	1.97" (50.0mm)
Height	0.25" (6.4mm)

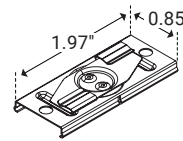

15/16" Grid Drop Tile



Unit Number	CB-DT-15
Ordering Code	15D
Width	1.36" (34.5mm)
Length	1.82" (46.2mm)
Height	0.49" (12.6mm)

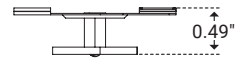
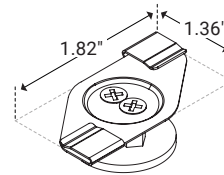

15/16" Grid Flat Tile



Unit Number	CB-FT-15
Ordering Code	15F
Width	0.92" (23.5mm)
Length	1.97" (50.0mm)
Height	0.27" (6.8mm)

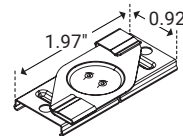

Surface



Unit Number	CB-SM
Ordering Code	SM
Width	0.85" (50mm)
Length	1.97" (21.6mm)
Height	0.16" (4.2mm)

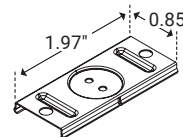



I Power & Connectors Options

Power Lead



REQUIRED ITEM Connects a CrossBar or group of CrossBar fixtures to the power supply.

Unit Number	Length
CB-FML-6	6ft (1.83m)

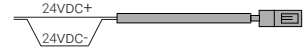

Y-Split Connector



Required to connect each additional CrossBar in a series of fixtures to a single power supply.

Unit Number	Length
CB-FMC-Y2	8" (200mm)

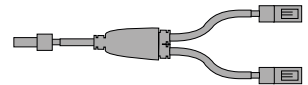

Jump Connector



Connects Y-Split connectors and the final fixture in the series. Do not connect CrossBar directly to another Crossbar with jump connectors.

Unit Number	Length
CB-FMC-6	6ft (1.83m)



I Wiring Diagram

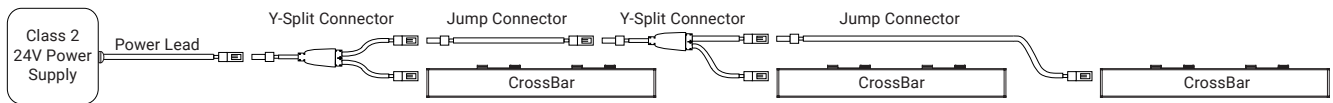



I Wiring Options

Primary Side Dimming (120V Only)

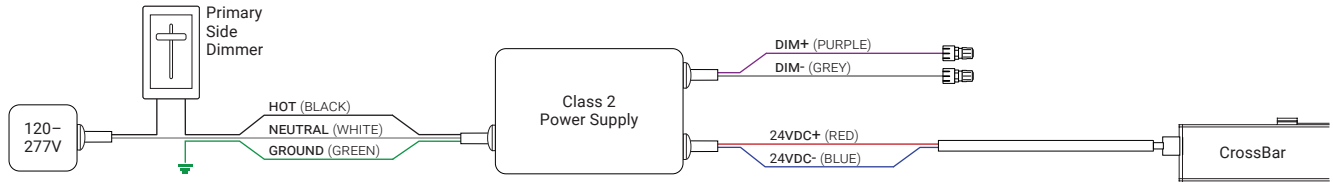

Primary Side Switching (120-277V)

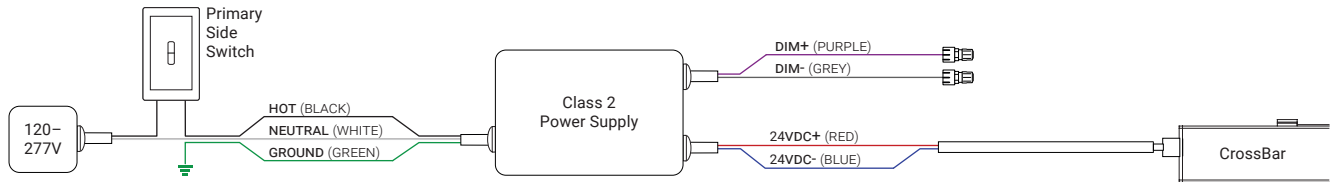

0-10V Dimming (120-277V)

