

FIXTURE TYPE _____

PROJECT NAME _____

LOCATION _____

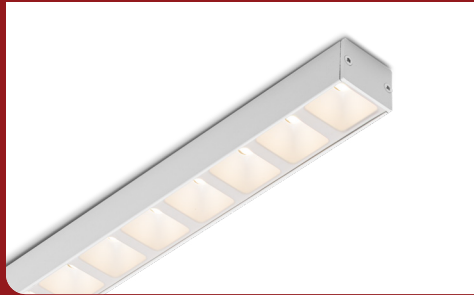

CrossBar™ White Louver

LOW CONTRAST PARABOLIC
LOUVER T-GRID FIXTURE

Store in a Temperature-Controlled Environment.



I Description

Crossbar provides seamless illumination upon either axis of a drop ceiling system, requiring no modifications to an existing T-grid.

I Features

- Low Contrast Parabolic Louver
- Easily Mounts to Existing Grid
- Fast Installation
- Integrated Seismic Strap
- UL Listed
- 50,000 Hour Life
- Multi-Volt 24VDC Remote Driver (Sold Separately)

I Specifications

| | |
|-----------------|---------------------------------------|
| Length | 2ft, 4ft |
| Temp/Color | 2700K, 3000K, 3500K, 4000K |
| Dimming Options | PWM, 0–10V, DMX 512, DALI, TRIAC, ELV |
| Finish | White |
| Input Voltage | 24V DC |
| Watts per Foot | 13W for 2ft, 26W for 4ft |
| Lumen per Foot | 1300 lm for 2ft, 2600 lm for 4ft |
| Lumens per Watt | 100 lm/W |
| Beam Angle | 75° |
| Max Run Length | 12ft |
| CRI | 90+ |
| Operating Temp. | -20°F (-29°C) to 158°F (70°C) |

I Product Code Builder

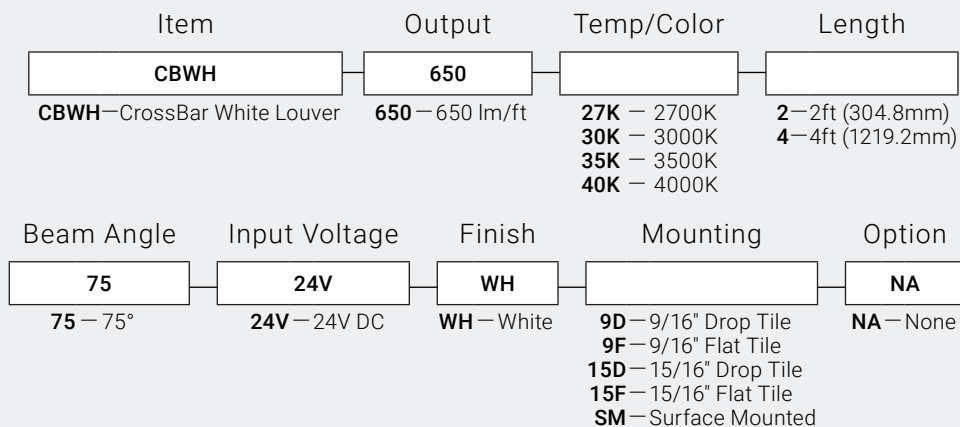

Example: CBWH-650-27K-2-75-24V-WH-9D-NA



Dimensions

| | |
|--------|---------------------------------|
| Length | 23.62" (600mm), 47.24" (1200mm) |
| Width | 1.00" (25.4mm) |
| Height | 0.79" (20.0mm) |

←CBWH-2 23.62" (600mm), CBWH-4 47.24" (1200mm)→

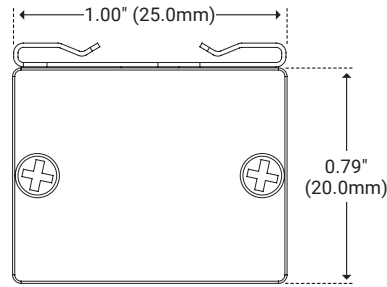

Mounting

9/16" Grid Drop Tile



| | |
|---------------|----------------|
| Unit Number | CB-DT-9 |
| Ordering Code | 9D |
| Width | 1.36" (34.5mm) |
| Length | 0.92" (23.5mm) |
| Height | 0.49" (12.6mm) |

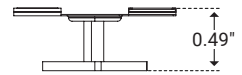
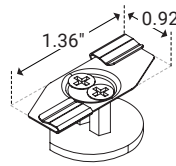

9/16" Grid Flat Tile



| | |
|---------------|----------------|
| Unit Number | CB-FT-9 |
| Ordering Code | 9F |
| Width | 0.85" (21.6mm) |
| Length | 1.97" (50.0mm) |
| Height | 0.25" (6.4mm) |

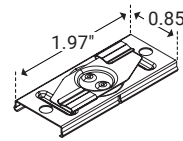

15/16" Grid Drop Tile



| | |
|---------------|----------------|
| Unit Number | CB-DT-15 |
| Ordering Code | 15D |
| Width | 1.36" (34.5mm) |
| Length | 1.82" (46.2mm) |
| Height | 0.49" (12.6mm) |

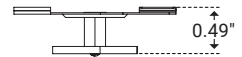
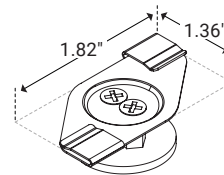

15/16" Grid Flat Tile



| | |
|---------------|----------------|
| Unit Number | CB-FT-15 |
| Ordering Code | 15F |
| Width | 0.92" (23.5mm) |
| Length | 1.97" (50.0mm) |
| Height | 0.27" (6.8mm) |

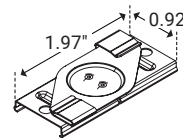

Surface



| | |
|---------------|----------------|
| Unit Number | CB-SM |
| Ordering Code | SM |
| Width | 0.85" (50mm) |
| Length | 1.97" (21.6mm) |
| Height | 0.16" (4.2mm) |

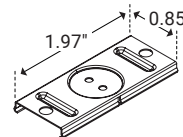



I Power & Connectors Options

Power Lead



REQUIRED ITEM Connects a CrossBar or group of CrossBar fixtures to the power supply.

| Unit Number | Length |
|-------------|-------------|
| CB-FML-6 | 6ft (1.83m) |

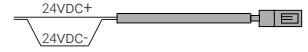

Y-Split Connector



Required to connect each additional CrossBar in a series of fixtures to a single power supply.

| Unit Number | Length |
|-------------|------------|
| CB-FMC-Y2 | 8" (200mm) |

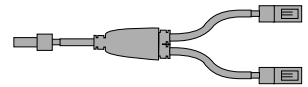

Jump Connector



Connects Y-Split connectors and the final fixture in the series. Do not connect CrossBar directly to another Crossbar with jump connectors.

| Unit Number | Length |
|-------------|-------------|
| CB-FMC-6 | 6ft (1.83m) |



I Wiring Diagram

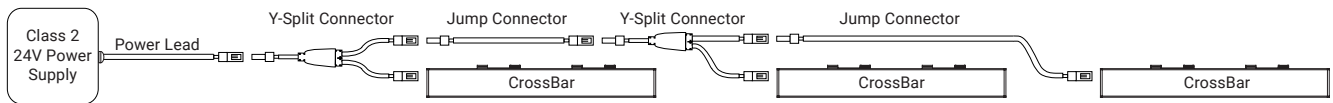



| Wiring Options

Primary Side Dimming (120V Only)

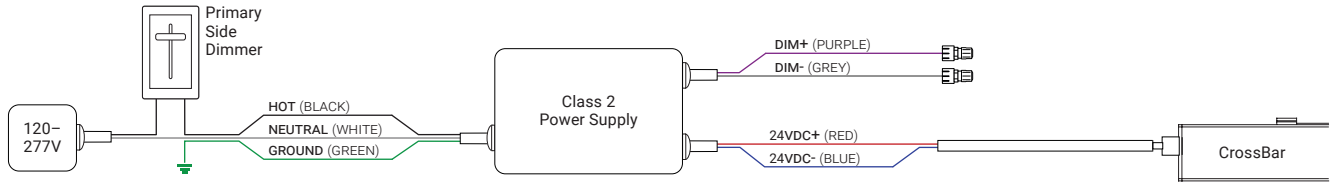

Primary Side Switching (120-277V)

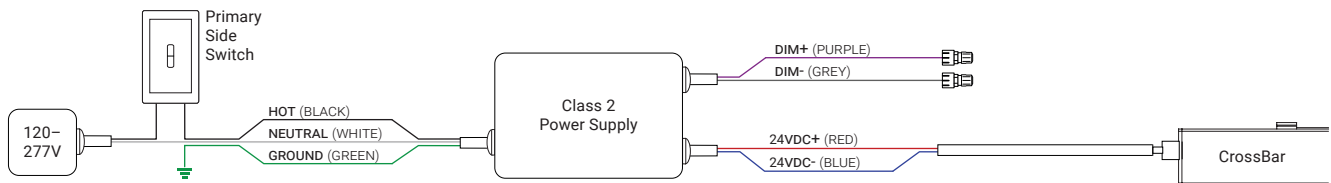

0-10V Dimming (120-277V)

