

FIXTURE TYPE _____

PROJECT NAME _____

LOCATION _____



BrightLinx

LOW VOLTAGE WASHER/GRAZER



Description

BrightLinx offers easy installation with a built-in cable raceway and a quick, plug-and-play connection system. With a polyurethane coating on top of our wash and graze lens options, this fixture is sure to withstand the elements and provide reliable performance for years to come.

Features

- Built-in Raceway for Simple Wire Management
- Vandal Proof Polyurethane Lens Coating
- Grazing and Wash Lenses Available
- Matte Anodized Aluminum Housing
- IP67 and IK10 Ratings

Dimensions

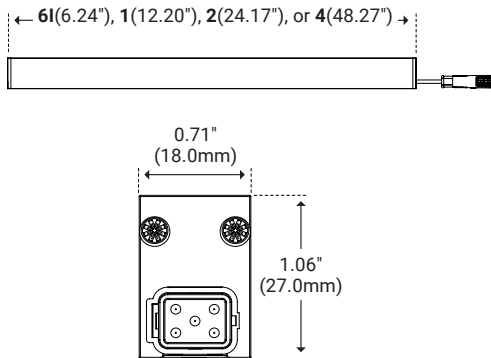

Specifications

Series	BTLX
Temp/Color	1800K–6500K, RGBW
Input Voltage	24V DC
Lumens per Foot	118–793
Watts per Foot	8 (Static White) 5 (Color Changing)
Beam Spread	35°, 45°, 120°
CRI*	90+
Diodes	2835 (Static White) 5050 (Color Changing)
Binning Tolerance	3 SDCM (Static White) -1 Bin
Length Options	6in, 1ft, 2ft, 4ft
Max Run Length	12ft (Static White) 20ft (Color Changing)
Width	0.71" (18.0mm)
Height	1.06" (27.0mm)
Dimming Options	PWM [§] , DMX [§] , 0–10V [§] , DALI [§] , ON/OFF
Operating Temp	-4°F (-20°C) to 145°F (62°C)

Beam Spread



* Customizable – Consult Factory

§ Additional Accessories Needed



Product Code Builder

Series BTLX BTLX – BrightLinX	Fixture Type W – Static White C – Color Changing	Temp/Color 189 – 1800K (90+ CRI) † 249 – 2400K (90+ CRI) † 279 – 2700K (90+ CRI) † 309 – 3000K (90+ CRI) † 359 – 3500K (90+ CRI) † 409 – 4000K (90+ CRI) † 509 – 5000K (90+ CRI) † 659 – 6500K (90+ CRI) † CC3 – RGBW (3000K) *	Dimming P – PWM D – DMX (Pixel Only)	
Power 8 – 8W/ft † 5 – 5W/ft *	Lens 35 – 35° Clear Lens 45 – 45° Clear Lens WH – 120° White Lens	Finish AA – Anodized Aluminum	Length 6l – 6in (6.24") † 1 – 1ft (12.20") 2 – 2ft (24.17") 4 – 4ft (48.27")	Option NA – None

† Compatible Only with Static White
 * Compatible Only with Color Changing
 † End of Run Only

Example: BTLX-W189P-8-35-AA-6l-NA

Series Data

	1800K	2400K	2700K	3000K	3500K	4000K	5000K	6500K	RGBW (3000K)
35° Clear Lens Lumens (per ft)	607	607	643	678	678	714	714	714	231
45° Clear Lens Lumens (per ft)	674	674	714	753	753	793	793	793	219
120° White Lens Lumens (per ft)	349	349	370	390	390	411	411	411	118
Wattage† (per ft)	8	8	8	8	8	8	8	8	5
Max Run Length (ft)	12	12	12	12	12	12	12	12	20

Built-in Raceway



† Power consumption based on average wattage per foot.

I Mounting

Recessed Mounting Channel



Unit Number	BTLX-CH-AL-1M
Unit Length	39.37" (1m)
Unit Width	1.05" (26.6mm)
Unit Height	1.48" (37.5mm)

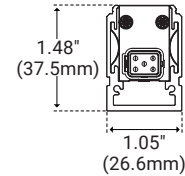

Surface Clip



Unit Number	BTLX-CP-M-PAK
Unit Length	0.98" (25.0mm)
Unit Width	0.71" (18.0mm)
Unit Height	0.29" (7.4mm)

5 surface clips in a pack, including mounting screws.
Recommend 2 surface clips per 3 ft of product.

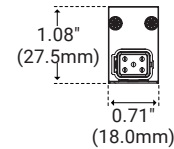

60° Bracket



Unit Number	BTLX-CP-PVT-60-PAK
Unit Length	0.98" (25.0mm)
Unit Width	1.54" (39.0mm)
Unit Height	0.95" (24.0mm)

5 brackets in a pack, including mounting screws.
Recommend 2 brackets per 3 ft of product.

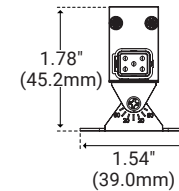

90° Bracket



Unit Number	BTLX-CP-PVT-90-PAK
Unit Length	1.18" (30.0mm)
Unit Width	0.71" (18.0mm)
Unit Height	0.34" (8.6mm)

5 brackets in a pack, including mounting screws.
Recommend 2 brackets per 3 ft of product.

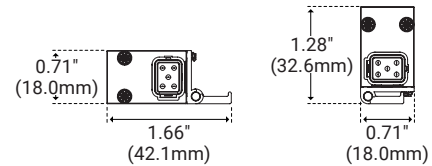

180° Bracket



Unit Number	BTLX-CP-PVT-180-1IN-PAK
Unit Length	1.18" (30.0mm)
Unit Width	0.71" (18.0mm)
Unit Height	0.94" (24.0mm)

5 brackets in a pack, including mounting screws.
Recommend 2 brackets per 3 ft of product.

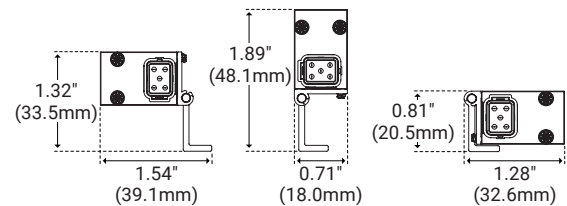



I Power & Connectors

Power Lead (Static White)



Unit Number	Length
BTLX-FML-6-2C	6ft
BTLX-FML-20-2C	20ft
BTLX-FML-50-2C	50ft

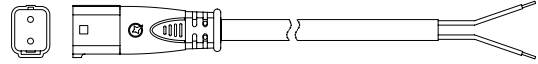

Power Lead (Color Changing)



Unit Number	Length
BTLX-FML-6-5C	6ft
BTLX-FML-20-5C	20ft
BTLX-FML-50-5C	50ft

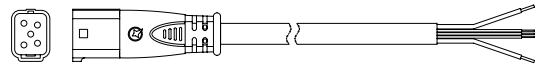

Jumper (Static White)



Unit Number	Length
BTLX-FMC-6I-2C	6in
BTLX-FMC-2-2C	2ft
BTLX-FMC-4-2C	4ft

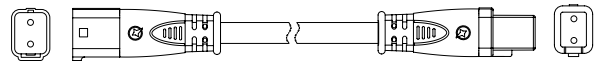

Jumper (Color Changing)



Unit Number	Length
BTLX-FMC-6I-5C	6in
BTLX-FMC-2-5C	2ft
BTLX-FMC-4-5C	4ft

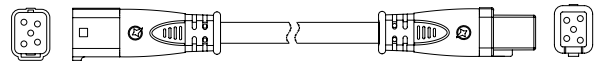

T-Connector (DMX Only)



Unit Number	Length
BTLX-PWR-FMC-6I-5C	6in
BTLX-PWR-FMC-2-5C	2ft
BTLX-PWR-FMC-4-5C	4ft

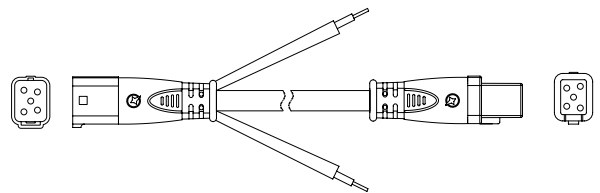

End Cap (Static White)‡



Unit Number	Description
BTLX-EC	Static White

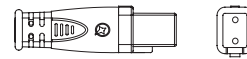

End Cap (RGBW-DMX)‡



Unit Number	Description
BTLX-DMX-EC	RGBW-DMX

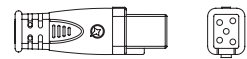

End Cap (RGBW-PWM)‡



Unit Number	Description
BTLX-PWM-EC	RGBW-PWM

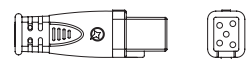

‡ If ending the run with a 6" BrightLinX fixture, the end cap is not needed.

^{||} Contains a 120 ohm resistor to terminate the DMX signal.



I Photometric Details

Static White – 35° Clear Lens – 4ft Fixture

Mtg Height	Eavg, Emax	Beam Diameter
1 m	1483, 21061x	54.06 cm
2 m	370.9, 526.61x	108.13 cm
3 m	164.8, 234.01x	162.19 cm
4 m	92.71, 131.61x	216.25 cm
5 m	59.34, 84.251x	270.31 cm
6 m	41.21, 58.511x	324.38 cm
7 m	30.27, 42.991x	378.44 cm
8 m	23.18, 32.911x	432.50 cm
9 m	18.31, 26.001x	486.56 cm
10 m	14.83, 21.061x	540.63 cm

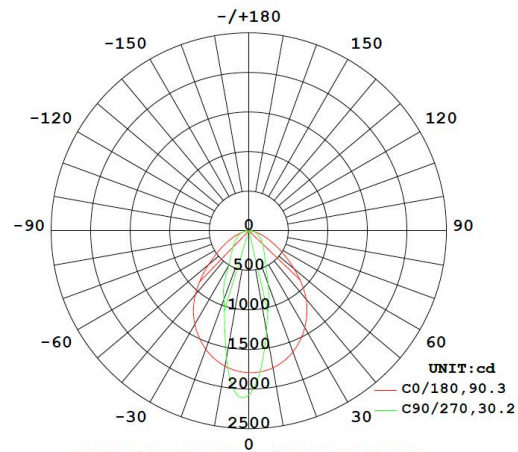

Static White – 45° Clear Lens – 4ft Fixture

Mtg Height	Eavg, Emax	Beam Diameter
1 m	1272, 16211x	86.27 cm
2 m	317.9, 405.31x	172.53 cm
3 m	141.3, 180.11x	258.80 cm
4 m	79.48, 101.31x	345.06 cm
5 m	50.87, 64.851x	431.33 cm
6 m	35.32, 45.041x	517.59 cm
7 m	25.95, 33.091x	603.86 cm
8 m	19.87, 25.331x	690.12 cm
9 m	15.70, 20.021x	776.39 cm
10 m	12.72, 16.211x	862.65 cm

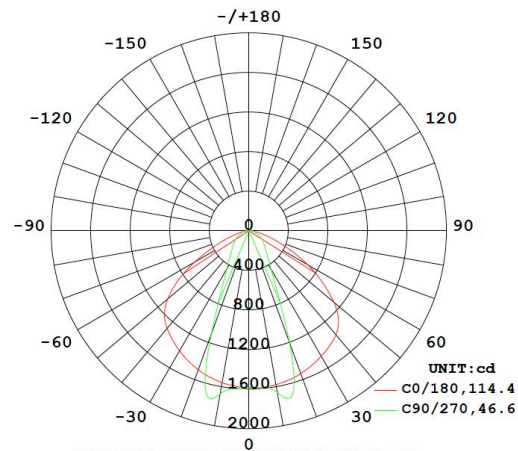

Static White – 120° White Lens – 4ft Fixture

Mtg Height	Eavg, Emax	Beam Diameter
1 m	154.3, 570.21x	309.37 cm
2 m	38.57, 142.51x	618.74 cm
3 m	17.14, 63.351x	928.10 cm
4 m	9.643, 35.641x	1237.47 cm
5 m	6.172, 22.811x	1546.84 cm
6 m	4.286, 15.841x	1856.21 cm
7 m	3.149, 11.641x	2165.58 cm
8 m	2.411, 8.9091x	2474.95 cm
9 m	1.905, 7.0391x	2784.31 cm
10 m	1.543, 5.7021x	3093.68 cm

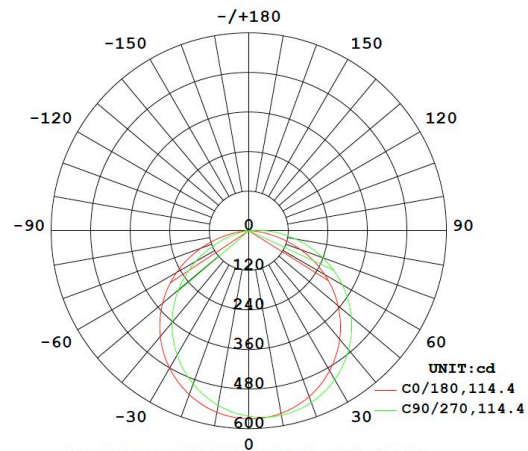



I Photometric Details

Color Changing – 35° Clear Lens – 4ft Fixture

Mtg Height	Eavg, Emax	Beam Diameter
1 m	500.5, 657.11x	63.67 cm
2 m	125.1, 164.31x	127.35 cm
3 m	55.61, 73.011x	191.02 cm
4 m	31.28, 41.071x	254.70 cm
5 m	20.02, 26.281x	318.37 cm
6 m	13.19, 18.251x	382.04 cm
7 m	10.21, 13.411x	445.72 cm
8 m	7.821, 10.271x	509.39 cm
9 m	6.179, 8.1131x	573.07 cm
10 m	5.005, 6.5711x	636.74 cm

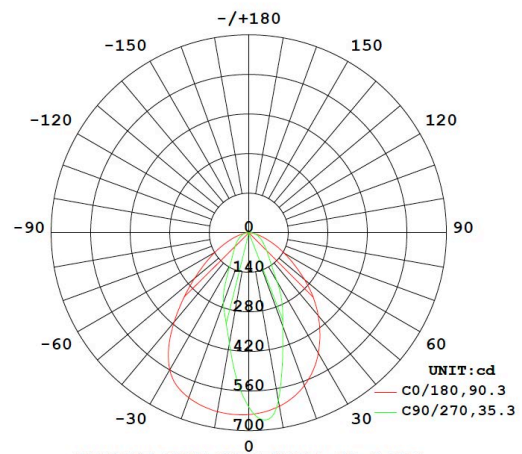

Color Changing – 45° Clear Lens – 4ft Fixture

Mtg Height	Eavg, Emax	Beam Diameter
1 m	389.4, 515.01x	91.42 cm
2 m	97.34, 128.71x	182.85 cm
3 m	43.26, 57.221x	274.27 cm
4 m	24.34, 32.191x	365.70 cm
5 m	15.58, 20.601x	457.12 cm
6 m	10.82, 14.301x	548.55 cm
7 m	7.947, 10.511x	639.97 cm
8 m	6.084, 8.0461x	731.39 cm
9 m	4.807, 6.3581x	822.82 cm
10 m	3.894, 5.1501x	914.24 cm

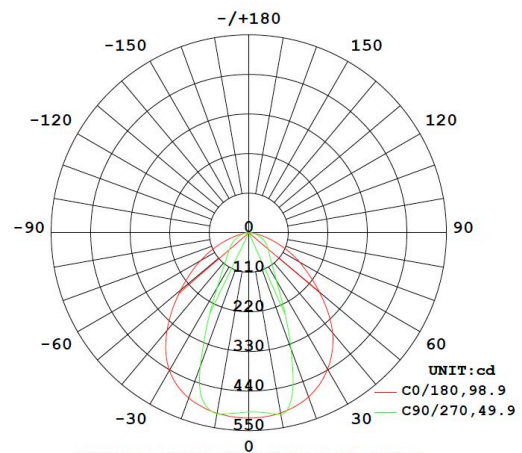

Color Changing – 120° White Lens – 4ft Fixture

Mtg Height	Eavg, Emax	Beam Diameter
1 m	47.78, 178.81x	310.69 cm
2 m	11.95, 44.711x	621.38 cm
3 m	5.309, 19.871x	932.07 cm
4 m	2.986, 11.181x	1242.76 cm
5 m	1.911, 7.1541x	1553.45 cm
6 m	1.327, 4.9681x	1864.14 cm
7 m	0.9751, 3.6501x	2174.83 cm
8 m	0.7466, 2.7941x	2485.52 cm
9 m	0.5899, 2.2081x	2796.21 cm
10 m	0.4778, 1.7881x	3106.90 cm

