

FIXTURE TYPE \_\_\_\_\_

PROJECT NAME \_\_\_\_\_

LOCATION \_\_\_\_\_



# Orex™

LINE VOLTAGE LINEAR LED TAPE



## I Description

Offering up to 500 lumens per foot, Orex is a simple indoor/outdoor line voltage solution to long run lengths requiring high output levels.

## I Features

- 120V Line Voltage
- Integral AC/DC Rectifier
- ETL, Triac, 0–10V (with LCX-1041)
- Hardwire or Plug-in Installation
- IP65

## I Series Spec

Series	RX
Temp/Colors	2400K–6500K
Input Voltage	120V AC
Watts per Foot	250 lm/ft = 3W/ft   500 lm/ft = 6W/ft
Beam Spread	120°
CRI	90+
Diode	3056
Orex Width	0.56" (14.3mm)
Orex Height	0.25" (6.5mm)
End Cap Length	2.50" (63.5mm)
End Cap Width	0.75" (19.0mm)
End Cap Height	0.37" (10.0mm)
Cut Intervals	3.00" (76.0mm)
Max Run Length	250 lm/ft = 120ft per Power Feed 500 lm/ft = 100ft per Power Feed
Dimming Protocol	0–10V (with LCX-1041) <sup>1</sup> , Triac, and ELV
Operating Temp.	-4°F (-20°C) to 107°F (42°C)
Installation Temp.	32°F (0°C) to 107°F (42°C)
Storage Temp.	-4°F (-20°C) to 140°F (60°C)

## I Dimensions

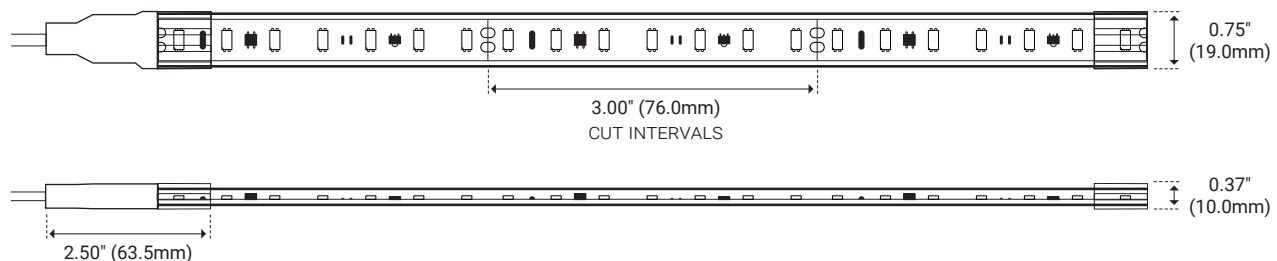

<sup>1</sup> See separate LCX-1041 spec sheet for more information.

Conforms to ANSI/UL Standard 1598  
Certified to CAN/CSA Standard C22.2 NO. 250.0



## I Product Code Builder

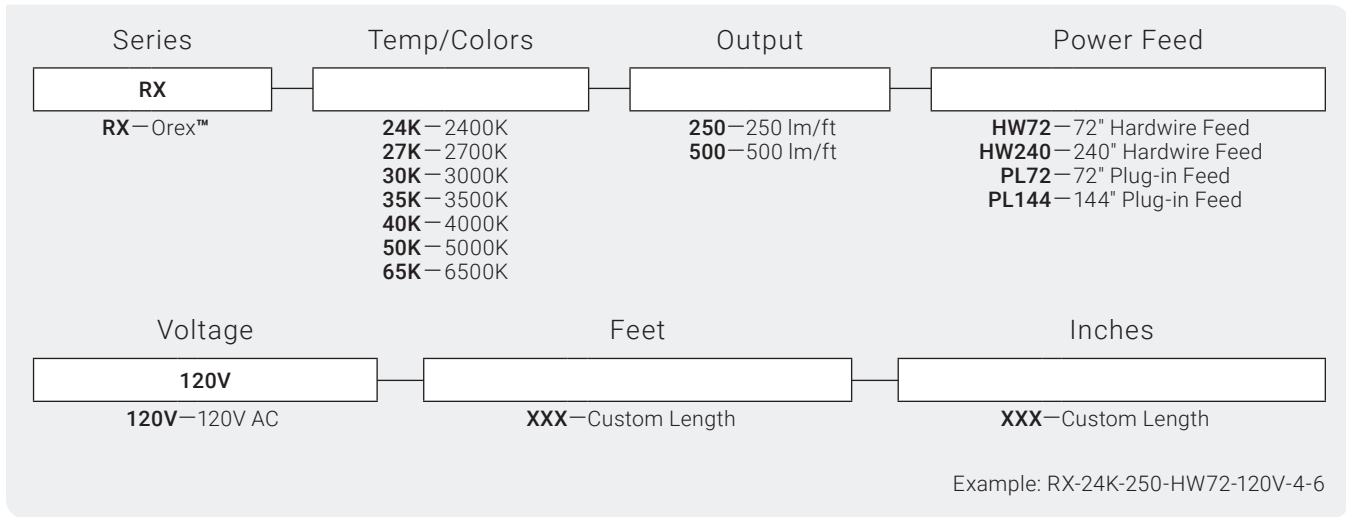

## I Series Data

	Configuration	2400K	2700K	3000K	3500K	4000K	5000K	6500K
Orex 250	Tape Only	222	251	256	263	268	276	279
	Tape, Channel, & Flat Lens	124	140	142	147	150	154	155
	Tape, Channel, & Square Lens	120	135	138	142	145	149	150
Orex 500	Tape Only	412	464	473	487	497	511	516
	Tape, Channel, & Flat Lens	237	267	272	281	286	294	297
	Tape, Channel, & Square Lens	245	275	281	290	295	304	306
% Difference from 30K	--	87%	98%	100%	103%	105%	108%	109%



# I Mounting Options

## Flat Aluminum Channel



### Channel & Lens Specifications

Model	RX-CH-TL-2-FL
Channel Material	Aluminum
Lens Material	Acrylic
Length	78.74" (2m)
Width	0.81" (20.0mm)
Internal Width	0.61" (15.6mm)
Light Transmission	57%

Includes 1 set of end caps, 5 mounting clips, and flat pixel free lens.

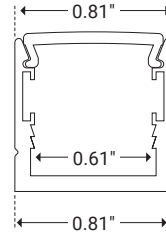

### End Caps Specifications

Model	RX-EC-FL-SD
-------	-------------

#### Start Cap Dimensions

Length	2.92" (74.23mm)
Width	1.52" (38.82mm)
Height	0.88" (22.5mm)

#### Finish Cap Dimensions

Length	1.27" (32.25mm)
Width	1.52" (38.82mm)
Height	0.88" (22.5mm)

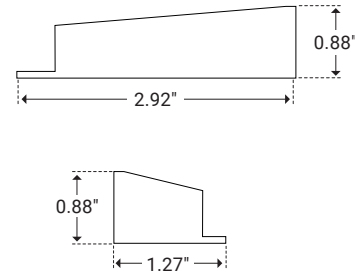

## Square Aluminum Channel



### Channel & Lens Specifications

Model	RX-CH-TL-2-SQ
Channel Material	Aluminum
Lens Material	Acrylic
Length	78.74" (2m)
Width	0.81" (20.0mm)
Internal Width	0.61" (15.6mm)
Light Transmission	57%

Includes 1 set of end caps, 5 mounting clips, and square pixel free lens.

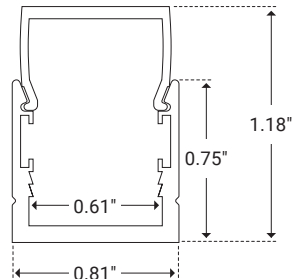

### End Caps Specifications

Model	RX-EC-SQ-SD
-------	-------------

#### Start Cap Dimensions

Length	2.92" (74.2mm)
Width	1.52" (38.8mm)
Height	1.26" (32.0mm)

#### Finish Cap Dimensions

Length	1.27" (32.0mm)
Width	1.52" (38.8mm)
Height	1.26" (32.0mm)

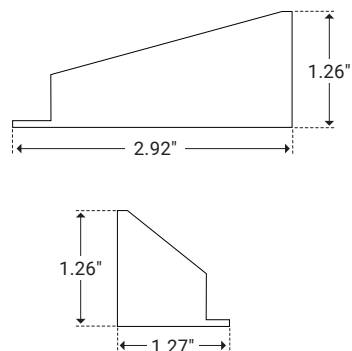



## I Mounting Options

### Plastic Mounting Base



#### Specifications

Model	RX-CH-PL-2M
Material	Polycarbonate
Length	78.74" (2m)
Width	0.75" (18.9mm)
Height	0.44" (11.3mm)

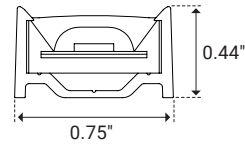

### Mounting Clips



#### Specifications

Model	RX-CLP-F1-PAK-P
Material	Polycarbonate
Length	0.56" (15.0mm)
Width	0.78" (19.8mm)
Height	0.44" (11.3mm)

Includes 10 Clips

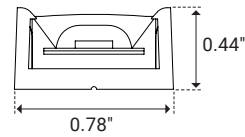

### 45° Mounting Clips



#### Specifications

Model	RX-CLP-A1-PAK-P
Material	ABS Plastic
Length	0.78" (19.7mm)
Width	0.97" (24.7mm)
Height	0.87" (22.0mm)

Includes 10 Clips

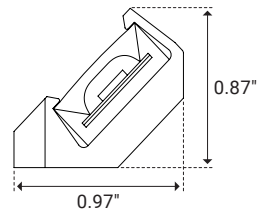

### 90° Mounting Clips



#### Specifications

Model	RX-CLP-V1-PAK-P
Material	ABS Plastic
Length	0.77" (19.6mm)
Width	0.52" (13.3mm)
Height	0.92" (23.3mm)

Includes 10 Dual Mounting Clips

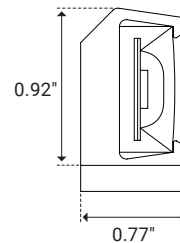

Base Mount



Back Mount





# I Hardwire Power & Connectors

## Hardwire Power Feed



Description	Ordering Codes
72" Length	HW72
240" Length	HW240

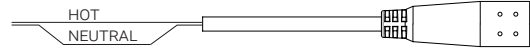

## Plug-in Power Feed



Description	Ordering Codes
72" Length	PL72
144" Length	PL144

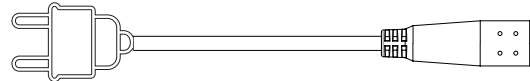

## Jump Cables



Description	Ordering Codes
6" Length	RX-JP-6
24" Length	RX-JP-24
48" Length	RX-JP-48

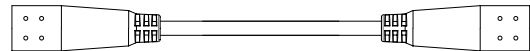

## Aluminum Channels Diagram

