

FIXTURE TYPE _____

PROJECT NAME _____

LOCATION _____



CH-217-N

EXTRUDED ALUMINUM MOUNTING CHANNEL



I Features

- Available in 2 Meter Sections
- Extruded Aluminum Construction
- Anodized Matte Finish
- Consult Factory for Custom Lengths & Finishes





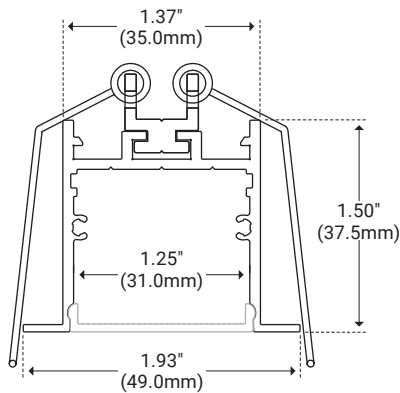

I Specifications

| | |
|----------------|----------------|
| Series | CH-217-N |
| Length | 78.74" (2M) |
| Width | 1.93" (49.0mm) |
| Internal Width | 1.25" (31.0mm) |
| Height | 1.50" (37.5mm) |

I Dimensions



I Options

| Description | Unit Number |
|--|-------------|
|  White Lens | WH |
|  Frosted Lens | FR |
|  Clear Lens | CL |
|  Spring Clips | SG |
|  90° Connector | -- |
|  90° Connector | -- |
|  120° Connector | -- |
|  180° Connector | -- |
|  End Cap With Hole | EC |
|  End Cap Without Hole | EC |

I Product Code Builder

| Series | Length | Lens | Mounting | End Cap |
|------------------------------------|--------------------------|---|-------------------------------|---|
| CH217N CH217N – CH-217-N | 2 2 – 2 Meters | WH – White FR – Frosted CL – Clear | SG SG – Spring Clip | EC EC – End Caps (included) Example: CH217N-2-WH-SG-EC |